

A “NEW CHURCH” DEDICATED TO St. PADRE PIO

— MASONIC TEMPLE? —

by Doctor Eng. Franco Adessa



F. Dr. Luigi Villa
Director of “Chiesa viva”



Dr. Eng. Franco Adessa
Collaborator of F. Luigi Villa

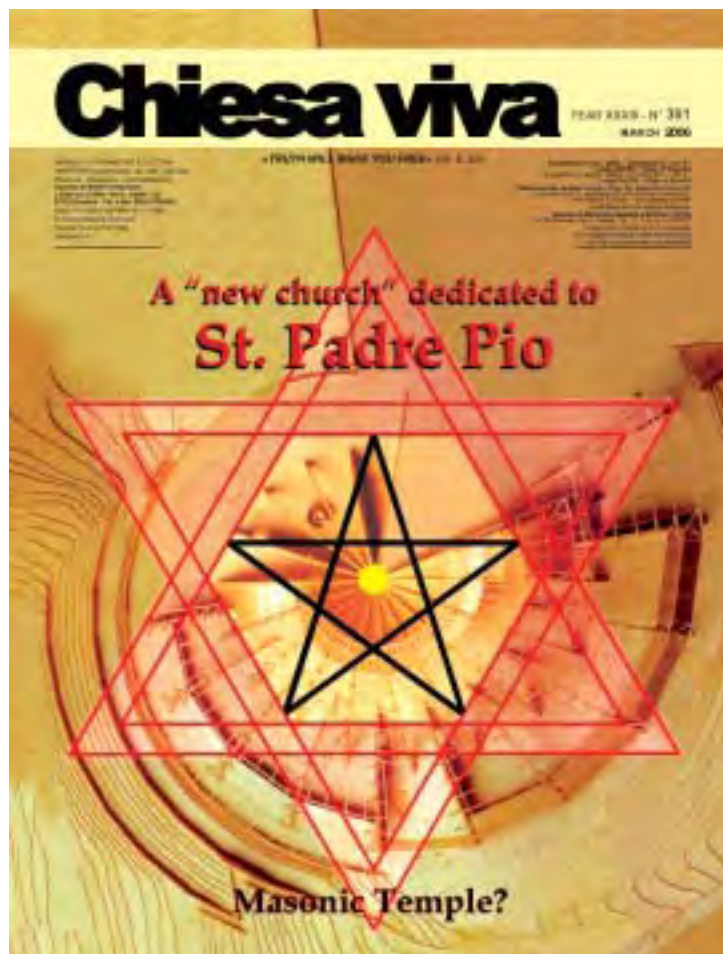

*The distribution of this Special Edition of “Chiesa viva” N° 381,
started on February 20, 2006.*



The “new church” dedicated to Saint Padre Pio, in San Giovanni Rotondo (Foggia) – Italy.

The essence of this detailed, meticulous and complete study
on the **“new church” dedicated to Saint Padre Pio,**
in San Giovanni Rotondo (Foggia) Italy,
is the following:

**THIS “NEW CHURCH” IS NOT A CATHOLIC CHURCH
BUT A “MASONIC TEMPLE”,
OR BETTER, A “SATANIC TEMPLE”
WHICH GLORIFIES MASONRY AND ITS “GOD”, LUCIFER.**

and where the Masonic symbology
celebrates the following horrible empieties:

**- THE REPLACEMENT OF THE HOLIEST TRINITY
WITH THE BLASPHEMOUS, SATANIC,
MASONIC “TRIPLE TRINITY”;**

- **THE REPLACEMENT OF JESUS CHRIST BY LUCIFER AS “MAN’S REDEEMER”;**
- **THE REPLACEMENT OF JESUS CHRIST BY LUCIFER AS “KING OF THE UNIVERSE”;**
- **THE REPLACEMENT OF THE “CULT OF GOD” WITH THE “CULT OF LUCIFER”;**

... and where the Masonic symbology
celebrates
the deadly weapon to destroy the Catholic Church:

- **THE “MASONIC ECUMENISM” OF THE REUNION OF ALL THE RELIGIONS.**

Despite the fact that the Vatican has not been able so far
to refute the conclusions
of this meticulous, detailed and complete study,

**THEY STILL CELEBRATE THE HOLY MASS
IN THIS “SATANIC TEMPLE”!**

Therefore “Chiesa viva” asks to prohibit the religious use
of this “Satanic Temple”
and tells the catholic Hierarchy:

- **THESE ARE SACRILEGIOUS MASSES!**
- **THIS IS A HORRIBLE INSULT TO JESUS CHRIST!**
- **THIS IS A CHALLENGE TO THE HOLIEST TRINITY!**

and asks them:

**UNTIL WHEN YOU WILL ALLOW MASONRY
TO INSULT**

**OUR LORD JESUS CHRIST
AND THE HOLIEST TRINITY?**

The CROSS

THAT SHAPES THE CHURCH

The shedding of the Blood of Our Lord, with His death on the Cross, constitutes the praiseworthy cause of our eternal salvation. It is from the Cross, that every spiritual benefit, every grace and the efficacy of the Sacraments come to us. For this reason, **the Church has always wanted to exalt the Crucifix, offering it continuously to the contemplation of her faithful. Hence, the entire Catholic spirituality is based upon the Cross!**

But not only is Jesus Christ crucified the praiseworthy cause of our Redemption; **He is also the exemplary cause of our life.** He is, of necessity, a model for each and every soul wishing to save and sanctify itself.

To take the Crucifix away from our eyes it is to lose the sense of sorrow; it is to lose the meaning of life.

And that is why the Crucifix, symbolic form of our Religion, has lent its imprint to the **“floor-plan” of the church**, en-



But what did the architects of those times of Faith wish to attain? To raise Basilicas, and Temples, in which to be able to aptly renew the **“Sacrifice” of the Mass, living memorial of the Sacrifice of Christ on the Calvary.**

Hence, they wished to recall the Victim of the Golgotha, attached to the Cross. **And here is the Cross, lone, immense, the nave and the transept representing the body and the open arms.**

The central altar represents the august head of the sacrificed God, and the chapels, with a sunburst pattern about the apse, form the glorious crown wreathing the forehead of the Savior of the world.

Mindful, then, that the Evangelist wrote that Jesus **“inclinato capite, tradidit spiritum”** (bowed His head, and rendered His Spirit), the builders of cathedrals have voluntarily bowed the chorus onto the arms of the transept and the head toward the shoulders»³.

closing in it a symbolic universe that has conferred upon its edifice the character of **“sacred place”**.

Reads the **“Dictionary of Architecture”**: «**The ancient Basilica of St. Peter**, in Rome, started around 320 AD and consecrated by **Pope Sylvester I** in 326, constituted one of the earliest examples of Christian architecture. It had the typical **Latin-Cross basilical floor-plan**, with the aula divided into five longitudinal naves and crossed perpendicularly by a transept»¹.

And further on: «Between the **VIII and XI century** it became prevalent, in Western ecclesiastical construction, the **Cross-shaped floor-plan** (“Latin” cross, that is, with axis of different length), **which took up the symbolic form par-excellence of the Christian Religion.** The short arm of the cross (transept) clearly distinguishes the presbytery from the central nave»².

The **Viollet-Le-Duc’s “Dictionary”** goes on to read: «In most of the **“floor-plans”** of Medieval churches, from the **XI to the XIV century**, it is observed that the axis of the nave and that of the Chorus form a line broken at the transept. It is a poignant symbolism; **it is an act of sublime faith to the eye of a Christian architect!**

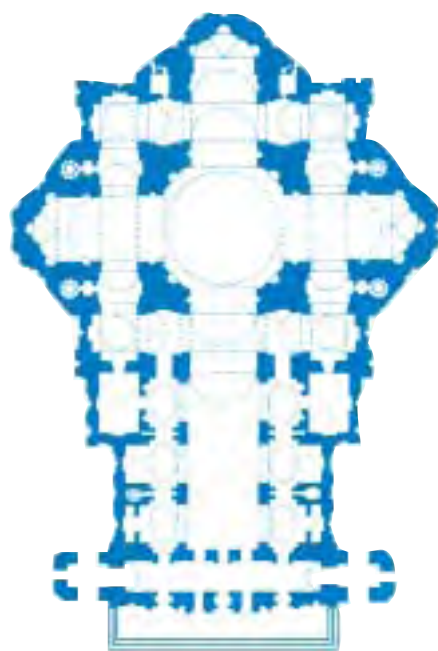

Floor-plan of Vatican Basilica – Baroque Period.

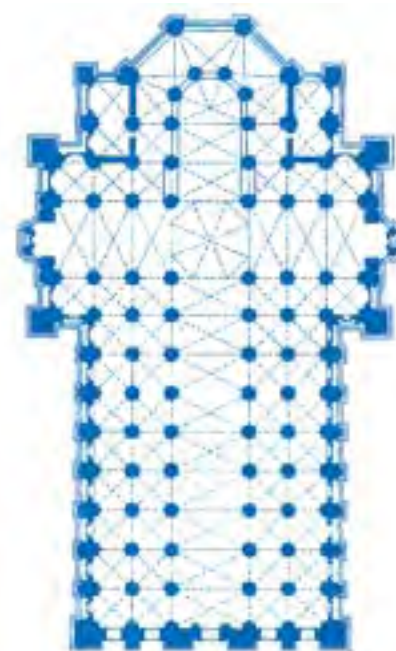

Floor-plan of Duomo of Milan.

THE CHURCH: A "SACRED" PLACE

Why is the church, as an edifice, also a "sacred" place?

«Our modern culture has lost sight of the concept of sacred for the reason that it has lost sight of the reality of God and of the sense of human life, caught in the whirlwind of erroneous theological premises which defined the reality of Faith so aseptically as to make it appear that truth had no relation with man. In this sense, the sacred per se, utterly removed from the faithful, has no sense whatsoever. It is sheer hallucination to affirm, therefore, that a created reality is holy in and of itself when conceived devoid of its real relation with the world. Based on this premise, one would come to two contradictory conclusions: everything is sacred; nothing is sacred. As objectivity, to be eloquent, must be perceived by the subject, and, therefore, must be subjectivized, so the sacred has its own sense when it is placed in relation with the person; when, that is, it interacts with the believer.

To conceive the sacred space of the church as something aesthetic (a common occurrence nowadays) it is to have no understanding!

The church is not important or "sacred" because it is beautiful, comfortable, and functional. What difference would there be, then, between the religious building and a multifunctional arena? None whatsoever! In fact, it is no coincidence that many churches, nowadays, resemble multifunctional arenas. At the origin of these constructions there exists, therefore, a hazy concept of Christianity and, perhaps, a Christianity that has lost the sense of its own Tradition.

To Tradition, each and every reality of the Church is linked to the faithful and it is in the service of his spiritual progress. The edifice of the church has, therefore, a "sacred" value because it contains inside of it a symbolic universe.

The believer who steps into an ancient Basilica finds himself before a prospective, before a path with a destination: the apse and the sanctuary.

The initial part of the church (Narthex) symbolizes the existential stage of he who approaches Christianity for the first time. Those waiting to be baptized paused in the area adjacent to the entrance door. All the internal area (Nave), instead, symbolizes the course of Faith in the believer. The Sanctuary, the place where the altar is located and where the Eucharist is celebrated, represents the place of the vision, the place in which the light of God reaches men to enlighten them. Therefore, it is no wonder that the majority of the ancient churches be oriented with the apse to the east, the place where the sun rises. (...).

The cosmic elements combine with the symbolic ones and both connect to the personal situation of the believer. Hence, in the ecclesiastical edifice the believer finds himself again before God.

The holiness of the church is, then, indication and reference of the holiness of the human person, for God reveals

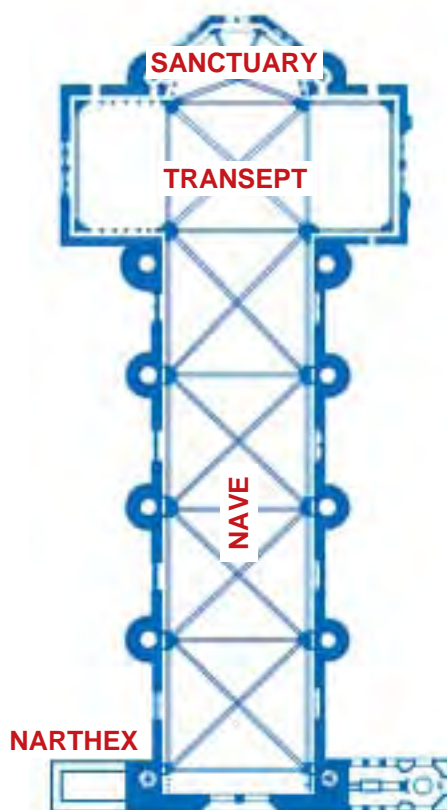

Himself in the hearts of men, and it is here that they must learn to discover Him»⁴.

The holiness of the church, besides the reference of the holiness of the person, also refers to a way of conceiving God. St. Simeon of Thessalonica (XV century) paused to describe the symbolic world enclosed in the Christian temple. In one of his writings, one observes what has been outlined above: the "sacred" edifice is the mirror of the interiority of man and of the mystery of God: «The temple, while made up of stones, wood and other materials, contains a supernatural grace. Once it has been consecrated by a Bishop, through mystical prayers and anointed with the holy chrism, it truly becomes the abode of God. As such, it is not totally accessible to everyone. The temple has a twin nature, as it features a place for the altar and a place external to it. In this manner, it represents Christ, who is God-man, who has a visible na-

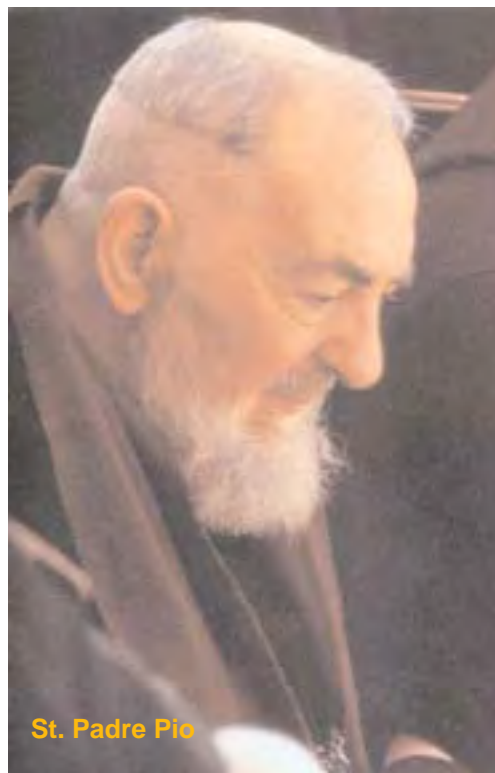

St. Padre Pio

ture and another nature that is invisible. Also, the temple represents man composed of soul and body. In addition, it represents above all the excellent mystery of the Holiest Trinity, inaccessible in her essence, but known in her providence and in her powers, revealing, similarly, the world of the visible things and of the invisible ones»⁵.

Here then stands the Cross, floor-plan of the holy place, lone, immense, with her nave, her transept and her Sanctuary, conferring upon the holy edifice the entire Catholic spirituality based upon the Cross: the essence of God, the essence of the Sacrifice of Christ on the Cross, the essence of the course of Faith in the believer for his own salvation.

This "immense cross" of the sacred place, therefore, is an act of faith and, at the same time, manifesting the excellence and sovereignty of God, as well as our dependence on Him, is also a grandiose and external act of cult.

A "NEW CHURCH" WANTED BY PADRE PIO?

In all the degeneration of the new spirituality of our times, which would like to hide the "negative" parts of Christianity focusing only upon that which stirs to joy, merrymaking, exhibition, and which affirms to be including the "best part" of the world, there emerges the figure of St. Padre Pio, the only stigmatized priest in the history of the Church, who, through his example, reminds all of mankind that he that wishes to be disciple of Our Lord must follow Him with the Cross, whose mystery he (St. Padre Pio) manifested for fifty years, bearing, inflicted into his body, the five bleeding wounds of the Crucifix!

How could one express a more heartfelt recognition for all his extraordinary spiritual work if not erecting and dedicating to St. Padre Pio a "new church" with a "Cross-shaped floor-plan," symbol of the mystery of the Holiest Trinity, symbol of the Sacrifice of Christ Redeemer, symbol of the path of Faith of every believer who looks forward to his own salvation, and symbol of those stigmata of Padre Pio which were the true cause of his power of intercession with God, in order to dispense all kind of grace to those turning to him?

Why, then, to this Saint Minister of God, to this Living Crucifix has not been dedicated a "Cross-shaped" church, but they wanted, instead, to attribute to him the will of longing for a spiral-shaped new church"?

¹ Cfr. "Architettura", *Architecture*, § 5.1 Paleochristian Architecture.

² Cfr. "Architettura", *Architecture*, § 5.3 Romanic Architecture.

³ Cfr. Viollet-Le-Duc's "Dictionary": text reported at the word "axe" (axis).

⁴ Cfr. "The Sacred Architecture" dictionary, p. 3-4.

⁵ Idem, p. 5.

The “NEW CHURCH” dedicated to St. Padre Pio

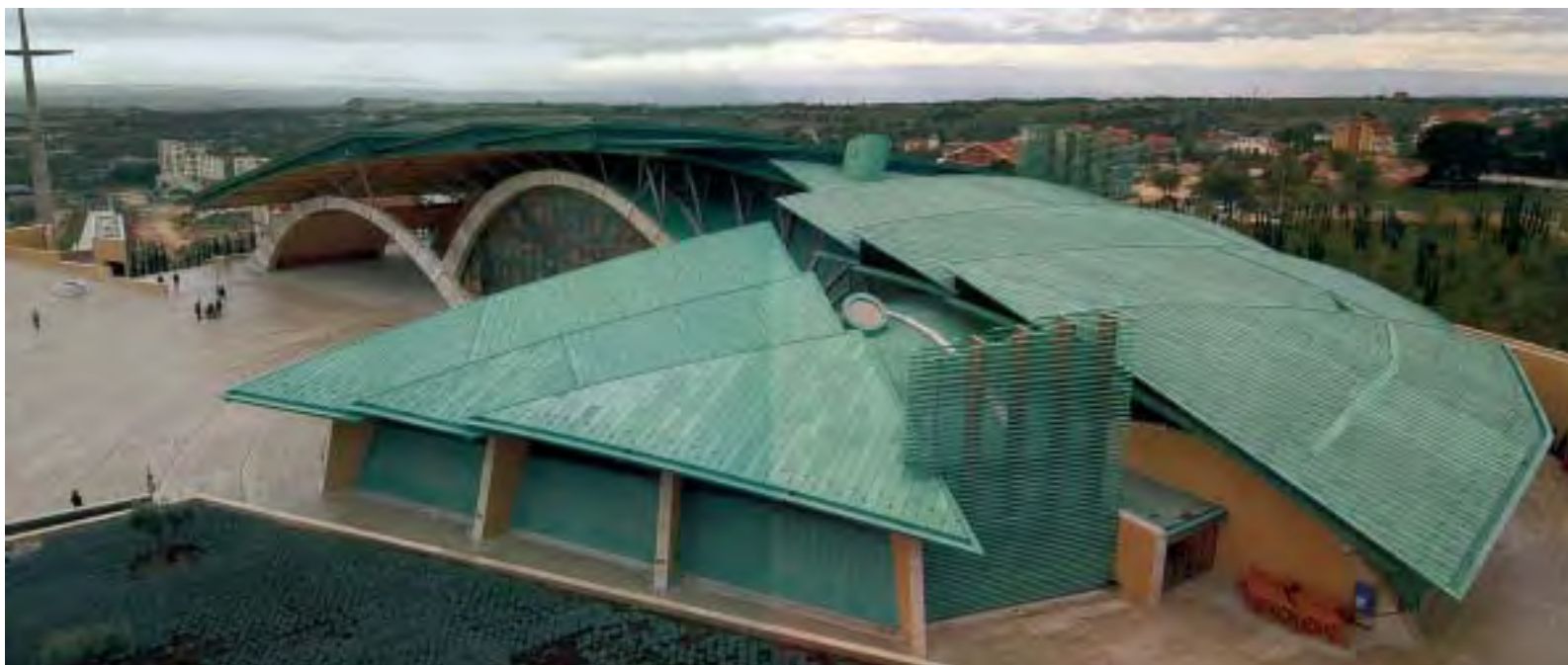

A front view of the "new church" dedicated to Saint Padre Pio, in San Giovanni Rotondo (Foggia) - Italy.



Mons. Crispino Valenziano, member of the **Pontifical Commission for the Cultural Estate** and direct supervisor of architect **Renzo Piano**, gave him the liturgical and theological bonds for the construction of the "new church", in order to have "the project gaining in expressiveness".

Mons. Valenziano, in the Pontifical Commission, was under the direction of **card. Virgilio Noè** and then of **card. Francesco Marchisano**, both having their names in the "**Lista of Pecorelli**", a list of **121 Prelate** of Roman Catholic Church belonging to Masonry.

Started on 19 January 1996, the "new church" dedicated to **St. Padre Pio** has been designed by the Genoese architect **Renzo Piano**, 62, foremost among the Italians and honored with the **Pritzker Prize** (the Nobel of architecture), in 1998.

Mons. Crispino Valenziano, member of the **Pontificia Commissione per i Beni Culturali**, *Pontifical Commission for the Cultural Estate*, on the other hand, has followed this impressive work from the **liturgical** and **theological** perspective, and speaks enthusiastically of this experience that, in his view, **offers the occasion «to share, as Church, in the context of modern art, and yet retain that thematic rigor characteristic of other epochs. Epochs in which the symbiosis**

between art and religious world was practically total and all-encompassing, as in the Middle Ages».

«Although at first - goes on **Mons. Valenziano - Piano's** inspiration looked back at the classical form of the Greek amphitheater, **the project has, in time, been gaining in expressiveness»¹.**

«While a proud man - goes on to explain **Valenziano - Piano** has been heedful, like few others, of the functional indications linked with the place of cult. And, in that, he has shown a great humbleness». In corroboration of this humbleness, to a reporter who asked him if, having to design a church with all the liturgical and theological bonds that come with it, he would feel any less free in his creativity, **Renzo Piano** replied: «Free? But for an

¹ Cfr. "Luoghi dell'infinito", *Places of the Infinite*, illustrated insert of *Avvenire*, Sept. 1998, p. 23.

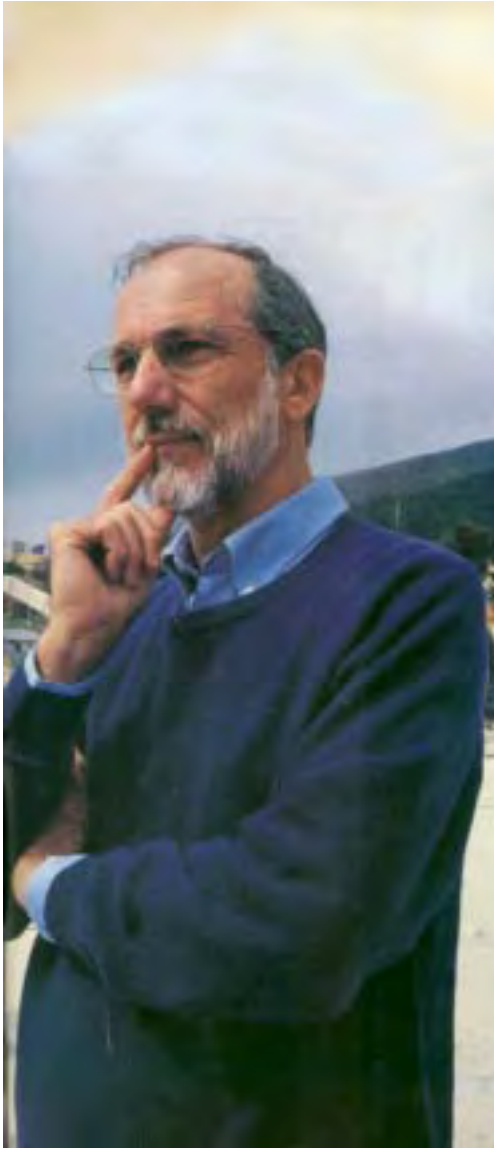

Architect **Renzo Piano**

architect freedom is not such a great boon. I thank God when I'm given clear-cut indications: they are like the squares on the great white sheet that is the project»².

In the same article, **Mons. Valenziano** assures us that «with the sole exception of the **seventeenth century Franciscan style Crucifix**, which will be installed in the Chapel of Penance, **all the other works will reflect the sincere religiosity of many contemporary artists who have devoted themselves to the sacred**»³.

Furthermore, he informs us: «I believed it essential that **no typology be imposed upon churches**. It is one thing to have a taste for beauty or tradition (chur-



The great wall and corridor of the "new church" bell structure.

ches built according to certain general canons), quite another to believe that churches be a static data, bound to a precise standard for all times»⁴.

In another article, however, **Mons. Crispino Valenziano** is introduced to us as the liturgical consultant «whose indications drove the architect **Piano** to revisit his initial project, in order to make it "a

model for all the churches that will be designed in the next five decades»⁵.

Now we ask ourselves: if **Mons. Valenziano** believes that churches must not be a "static data", **why is he so eager to impose this model of church for the next fifty years?**

If we may speak our mind, we should say: what a mix-up! But the subject is too

² Idem, pp. 24-25.

³ Idem, p. 25.

⁴ Cfr. Crispino Valenziano, "Architetti di

chiese", *Architects of Churches*, the epos, quoted in the article of: "Il Giornale" (daily), 25 June 1999, p. 19.

⁵ Cfr. "Famiglia Cristiana" magazine n° 10, 2002, p. 33.

serious, and so we wanted to gather information and we felt edified in reading the words of the famous historian of religious architecture, **Erwin Panofsky**, whom, in a famous work of his, wrote: «**There exists an intimate bond between the way of building a church and the way of thinking and living of men. To live outside of Christianity, or in a corrupted or secularized form of Christianity, produces more or less the same results. It must be stated that when it (the church) is born of non-Christian artists and architects it (church) might even turn out very interesting, but IT WILL NEVER BE AN EXPRESSION OF CHRISTIANITY**»⁶.

We did, however, plunge back into doubt when we read, on a recent magazine, the verdict of another famous historian of architecture, the Swiss **Kurt W. Forster**, who taught in the United States for over 25 years at **Yale, Stanford**, and at the **MIT**. In an article titled “**Great Architects Can Do Away With Faith**,” when asked: «Professor Forster, a **secular rationalist** such as **Renzo Piano**, is confronted with the Catholicism of the miracles; what will the outcome be?», he replies: «The conflict is only apparent. (...). **An artist does not have to connect.** Great architects have successfully tackled these themes (...). To **Piano**, it is just another challenge. **A man of profound secular experience can give truth to phenomena for which we**



*On June 11, 2005 at 11 o'clock, this bronze Bell, dedicated to **Saint Michael Archangel** and to **Padre Pio**, broke free and fell breaking in thousand pieces. The bell weighed 18 hundred kilos (18 = 6 + 6 + 6 = 666, which represents the **Mark of the Beast** and the number of the **Antichrist**).*

have no rational understanding. The Big Bang replaces the story of Genesis: it is our world⁷.

At this point, we asked ourselves: the project of the Catholic church that, after **St. Peter**, is the largest in the world, is

entrusted not to a Christian architect, but to “**secular rationalist**”, to a “**man of profound secular experience**” whom, “**without faith**” and “**without connecting**”, is able to “**give truth to phenomena for which we have no rational understanding**”.

But... that man was the same who humbly followed the “**precise indications**” that were given him, and who was **even happy to relinquish his freedom of creative expression** when he was devoted to a project. But then, we ask ourselves: **whose creative expression and “truths” are those that have been imprinted into his work?**

To us it looks like utter confusion. One important thing, however, seems quite clear to us: “**the story of Genesis has been replaced by the Big Bang**”; a doctrine, the latter, which has the subtle claim of eliminating God Creator from that which Forster calls “**our world!**”.

To deny creation from nothingness there is only one other “**world**”: **that which makes of the war to the supernatural its one and only “dogma”**: the Jewish-Masonic world!

Thank you, doctor K.W. Forster!

⁶ Cfr. Diction. “**L’Architettura sacra**”, *Sacred Architecture*, p. 2.

⁷ Cfr. “**L’Espresso**” magazine, 24 October 2002, p. 171.



A rear view of the “new church” dedicated to Saint Padre Pio, in San Giovanni Rotondo (Foggia) - Italy.

Why a “SPIRAL-SHAPED”



What meaning does the “spiral” have in Christian symbology? None whatsoever! Why, then, it was blatantly chosen to give “form” to the structural architecture of the “new church” dedicated to St. Padre Pio? They told us that this “spiral-shaped” church, “is a spider”, is an “Open Church”, is a “High Technology Jewel”, is a “Seashell for Padre Pio” and that the Saint shall be like the pearl inside of it. They also told us that this new church has been freshly baptized “Cathedral of Two-Thousand”, “New Assisi”, “Divine Project!”... But, they have not said to us that the “Masonic Dictionary”, at the voice “spiral”, reads: «Very ancient sign symbolizing the existence of man and his return to the origin... (the spiral) symbolizes also the dynamic force of the universe, the Creative Principle, the G.A.O.T.U. (...)»¹. The same Dictionary, at the voice G.A.O.T.U., explains: «Masonic abbreviation to indicate God, Great Architect Of The Universe»². And who is this “God”, called G.A.O.T.U.?

It is the God of Freemasonry. In fact, already in the General Statutes of 1820, it was said: «(Freemasonry) has for its principle the existence of a God whom it adores and respects under the commonly accepted title of Great Architect of the Universe»³. But the G.A.O.T.U. is proclaimed by Freemasonry also as “Creative Principle” (in the meaning, however, of “principle of generation” and not of “creation from nothingness”!). In the Great Alliance Treaty, signed at Lausanne (Switzerland) in 1875, among the Supreme Councils of the Ancient and Accepted Scottish Rite, it was in fact affirmed: «Freemasonry proclaims what it has proclaimed ever since its inception: the existence of a Creative Principle, under the name of Great Architect of the Universe»⁴. To define the G.A.O.T.U. as “dynamic force of the universe” is, instead, the founder of the Theosophic Society, Helena P. Blavatsky, freemason of the 33 degree who, with all her authority, wrote: «Satan represents the active Energy

of the Universe (...). He is the Fire, the Light, the Life, the Fight, the Struggle, Thought, Conscience, Progress, Civilization, Freedom, Independence»; and again: «Satan is the God, the only God of our Planet»⁵.

The yet more authoritative seal as to who the true God of Freemasonry is, comes to us from the Supreme Pontiff of Universal Freemasonry, general Albert Pike whom, as Freemasonry’s Supreme Chief, in a speech held in France in 1889 to the high degrees of Freemasonry, stated: «We worship a God, but it is the God one worships without superstition (...). We initiated of the high degrees, should maintain the Masonic Religion in the pureness of the Luciferian doctrine. (...). Yes, Lucifer is God (...) the true and pure philosophic religion is the faith in Lucifer (...) but Lucifer God of Light and God of Good is struggling for humanity against Adonai (the One and Trine God - author’s note) god of darkness and demon»⁶.

Hence, the “spiral” symbolizes the G.A.O.T.U., namely Lucifer-Satan, whom, as we well know already, has engaged against the God One and Trine a fight to the death for the perdition of man.

The “spiral”, however, not only symbolizes the way Freemasonry conceives God, but also symbolizes its way of conceiving the “path of faith” or, better, the “initiatic course” man is expected to follow in order to fulfill the “divine design”. In a highly documented book on Freemasonry, we read, in fact: «The Spiral is a sign of evolution-involution in the symbolic background of high-ranking initiates. The continuous Spiral that, in the form of a path, climbs along the flanks of the mountain is the “Pilgrim Path”, that is, the initiatic path. The peak of the mountain fades into a vertical line toward the spiritual infinite: it is the axis of the world, “universal Axis” of the sole truth professed by High Freemasonry, the passage between earth and heaven configured by Gnosis: the divinization of Man»⁷.

Giuseppe Mazzini, Head of Political Action of Universal Freemasonry and co-founder, with Albert Pike, in 1870, of

¹ Cfr. Luigi Troisi, “Dizionario massonico”, *Masonic Dictionary* - Bastogi Editrice Italiana, p. 377.

² Idem, p. 173.

³ “Statuti Generali”, *General Statutes*, of 1820, Ed. Civelli Rome 1908, V.

⁴ Salvatore Farina, “Il Libro dei Rituali del

Rito Scozzese Antico e Accettato”, *The Book of the Rituals of the Ancient and Accepted Scottish Rite*, Rome, Piccinelli 1946, p. 304.

⁵ H. P. Blavatsky, “La Dottrina segreta”, *The Secret Doctrine*, Ed. Bocca, Milan 1953, p. 400 and 383.

⁶ An excerpt of this speech was reported by the British magazine “The Freemason” in its issue of 19 January 1935.

⁷ Cfr. Epiphanius, “Massoneria e sette segrete: la faccia occulta della storia”, *Freemasonry and Secret Sects: The Occult Face of History*, p. 193.

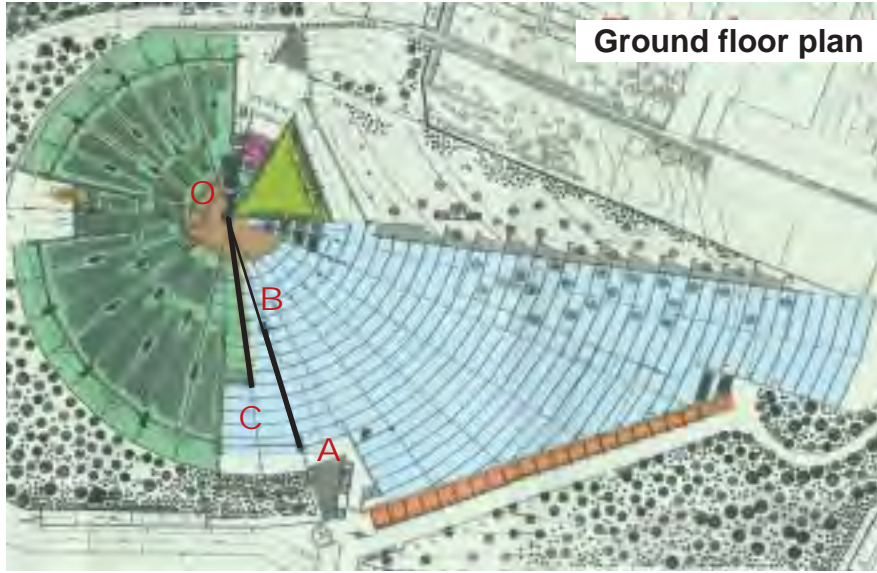

Ground floor plan of the "new church" composed of 15 internal arcs and 11 external ones.

The **spiral**, however, according to the experts of Masonic symbology, can take on features much more familiar to us. In the work of **Jules Boucher**, "**Masonic Symbology**", we read: «The number **9** represents, in its graphism, a **descending germination**, hence material; whereas the numeral **6** represents, on the contrary, an **ascending germination**, hence spiritual. These two numbers are **the beginning of a spiral**»¹⁰.

"The New and Reformed Palladian Rite", supreme vertex of Masonic Obediences worldwide, besides the existence of God (**the G.A.O.T.U. = Satan**) it recognized the principle of the **"Law of Progress"** «whose continuity appears evident not to the life of each people separately, but to that of Humanity for which peoples are individual and, **only then, one will discover the immense indefinite spiral, designed by the finger of God between the Universe and the Ideal that must gradually be reached**»⁸.

Setting aside the high-sounding language, used for the naïve and the unaware, let us see, now, what this **"immense indefinite spiral, designed by the finger of God"** consists in, and the **"Ideal one is to reach"**, better described in some personal letters **Mazzini** and Freemasonry's Supreme Chief, **Albert Pike**, exchanged in the years 1870-1871.

In his letter of 22 January 1870, **Mazzini** exposed **his plan of three World Wars for the Twentieth century with the purpose of creating a Communist State in Russia** (first War), and cause it to expand to **include half of Europe** (second War), and render it politically and militarily powerful in anticipation of the **third War, which would burst out between political Zionism** (including the State of Israel) **and Islam, toward their mutual destruction, together with all the other Nations**, dragged into the conflict in order to fight one another until their complete physical, moral, spiritual, and economical collapse.

Albert Pike, in complete agreement with this infernal plan, better detailed the objectives of the Third World War in a letter of 1871: «We will unleash the nihilists and the atheists and will provoke a formidable social cataclysm which will clearly show all nations, in all its horror, the effect of absolute atheism, origin of barbarism and of bloody subversion. **Then, everywhere, the citizens, compelled to defend themselves against a worldwide minority of revolutionaries (...)** will receive the true light through the universal manifestation of the pure doctrine of **Lucifer, revealed at last to the public eye; manifestation that shall be followed by the destruction of Christianity** and of atheism, conquered and crushed at the same time!»⁹.

To the echelon of **Freemasonry**, therefore, the **"Path of faith in Progress"**, represented by the **immense and indefinite "spiral"**, is non other than the **destruction of the Catholic Church and of the Christian Civilization, to be enacted through the universal manifestation of the pure doctrine of Lucifer, revealed at last to the public eye! "The Ideal that must be gradually attained" is, therefore, the "Cult of Lucifer" in full daylight!**

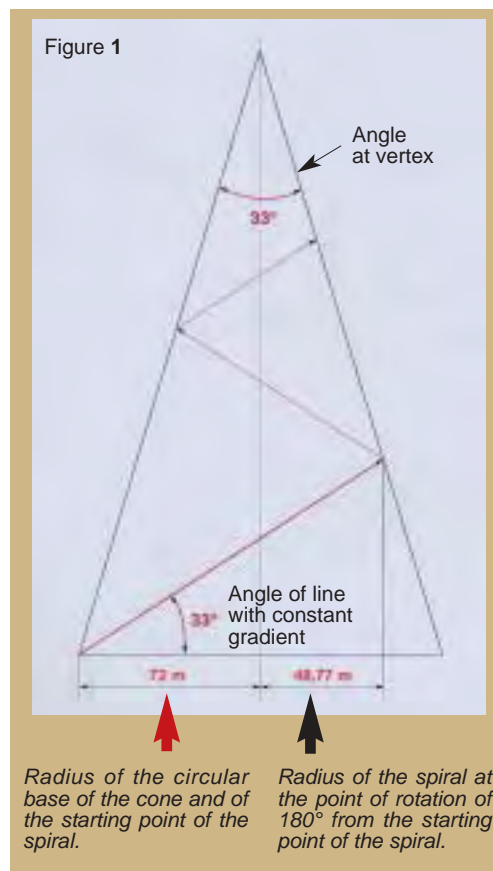

Radius of the circular base of the cone and of the starting point of the spiral.

Radius of the spiral at the point of rotation of 180° from the starting point of the spiral.

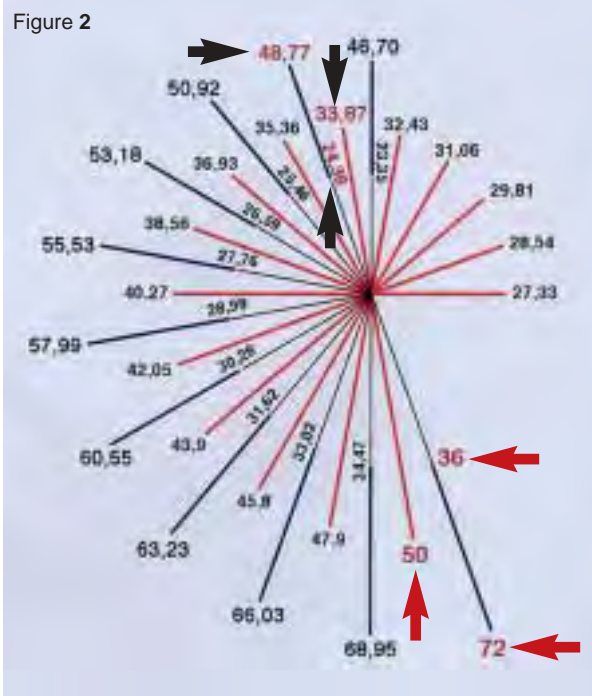

The manner of generating a **spiral** is very simple if observed geometrically: taking a cone, with a prefixed radius of the base circle and an angle at the vertex, tracing a line, with a constant gradient, on its external conical surface, observing its projection onto the base of the cone one observes a geometrical form: **the spiral**. Varying the radius of the base circle and the angle at the vertex, one also varies the manner in which the spiral contracts toward the central axis as it spins.

Choosing a radius of the base circle of the cone of **72 m (= OA)**, deduced from the ground floor-plan of the Church), an angle at the vertex of **33°** and a gradient of **33°** of the line traced on its surface, the radius of the spiral, after a rotation of **180°**, is reduced to **48.77 m** (see figure 1) while the measures of all the other radiuses of this spiral, at **20°** from one another, are reported in figure 2.

Choosing, now, the base radiuses of **36 m (= OB)**, distance from center of internal extremity of arc BA), and of **50 m (= OC)**, radius of longest of 15 internal arcs, and of span = 50 m), repeating the same procedure, after a **180°** rotation one obtains, respectively, the radiuses of **24.38 m** and **33.87 m**, while the measures of all the others are reported in figure 2.

Now then, the **11 external arcs** and the **15 internal ones**, thus obtained, coincide exactly with the **26 arcs of the "new church" dedicated to St. Padre Pio!** Hence, the **"generating principle"** of the **three spirals**, which determine the measures of all the arcs of the **"new church"**, are the angle at the vertex of **33°** and the angle of **33°** of the line with constant gradient, traced upon the external surface of the cone to generate the spiral.

⁸ Cfr. Luigi Troisi, "**Dizionario massonico**", *Masonic Dictionary*, cited work, p. 261.

⁹ **Jean Lombard** informs us that this correspondence between **Pike** and **Mazzini** lies in the archives of Temple House, Washington headquarters of the Freemasonry of the Scottish Rite, but unavailable!

¹⁰ Cfr. Jules Boucher, "**La simbologia massonica**", *Masonic Symbology*, Atanor, Paris 1948, p. 285.

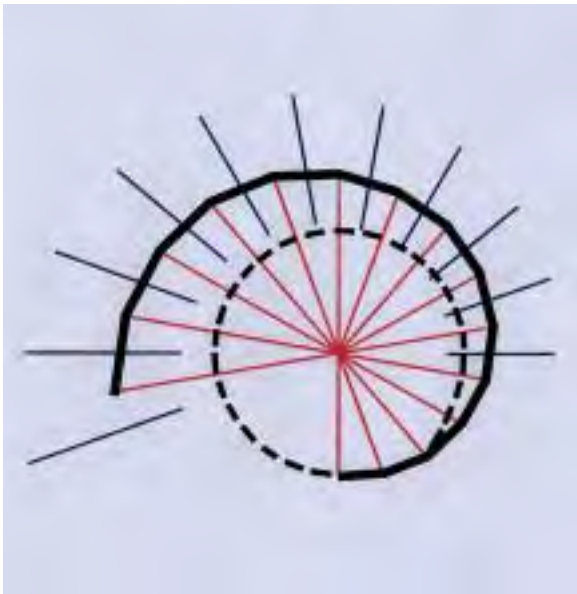

Connecting the external points of the **15 internal arcs**, highlighted in red, a spiral is obtained which, enclosed with an arc of circle in its narrowest point, is non other than a **reversed 6** (see figure on the left).

If the spiral is turned upside down (as if observed from under the ground) there appears clearly the numeral **6** (see figure on the right). Now, if all the there series of extremities of the internal and external arcs are connected, **three spirals** are obtained (see figure below) which, enclosed with arcs of circle in their narrowest point, portray **three 6 as seen upside down**.

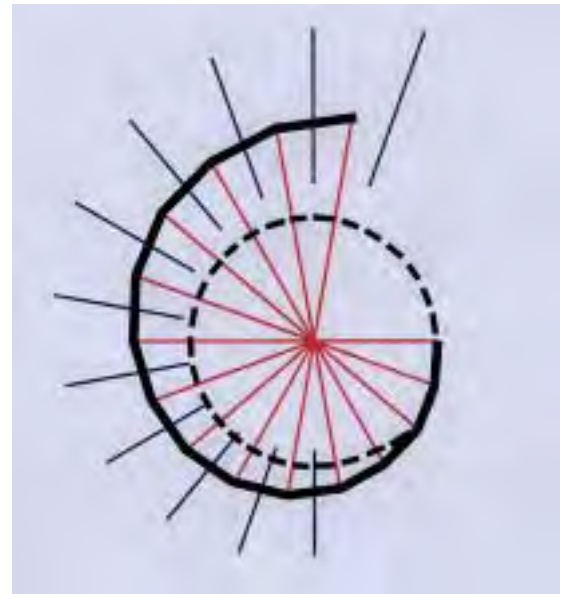

THE "MARK OF THE BEAST" 666

The connection between **spiral** and the numerals **6** and **9** is better illustrated to us by **R. K. Spenser**, whom, speaking of the mural fresco of the **Meditation Room at the UN**, writes:

«The **spiral-shaped** figure that winds around the diagonal line of the fresco, symbolizes the **Caduceo** of Mercury, which, mythologically, is represented by two **snakes** coiled around Mercury's magic wand. The intersection of the **spiral** with the diagonal forms **9 arcs**; the **9th** Hebrew letter "**Teth**", which has the value of **9**, means "**Snake**". The **Number of the Beast** in (the Book of) Revelation is **666**, which kabalistically is represented by the **number 9**, the number of Generation»¹¹.

The justice **Carlo Alberto Agnoli**, a Freemasonry scholar, wrote in one of his works: «**The Masonic pyramid, which subordinates everything to the vertex, has the profoundest message when it is turned downward**, in compliance with the teaching contained in the Masonic word **VITRIOL**, which is presented to the neophyte already in the "**Chamber of Reflection**" when he joins Freemasonry, and which consists of the initials of the motto: "**Visita Interiorum Terrarum, Rectificando Invenies Occultum Lapidem**", namely, "**visit the depth of the earth; rectifying, you shall find the hidden stone**", namely, the "**Philosopher's Stone**" of the Great Sectarian Work.

The Masonic hierarchy, like its own doctrine, does not shine up high, in the clearness of sunshine, but it is plunged into the obscurity of the abyss. That it is a realm of the abyss it is also expressed in these famous verses by the famed **Mason Olindo Guerrini**:

*But from the abyss a canticle
Up to the Lord's spaces soars
Blessed be Satan
Who handed Eve the apple of sin!*¹².

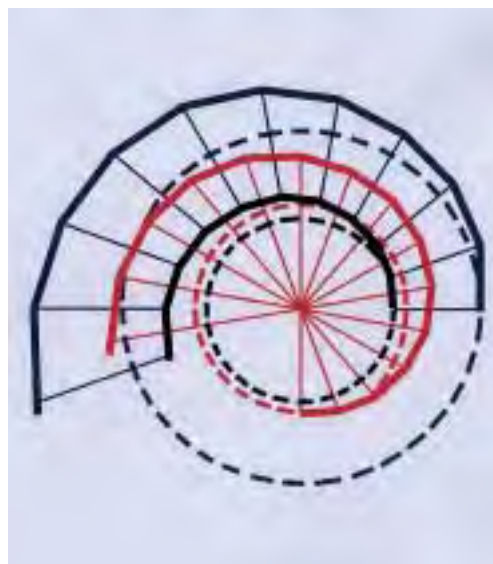

Turning these three spirals upside down, always as if observed from under the ground, there appears, in all clearness (see figure below), **an enormous 666, the "Mark of the Beast" and the symbol of the Anti-Christ!**

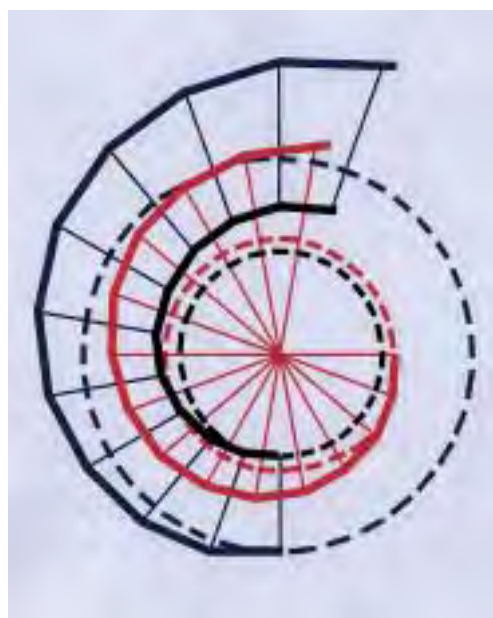

It is in fact from this abyss, turned toward the "**spaces of the Lord**", that the **three spiral sections**, generated by the resting points of the 26 arcs of the "**new church**", enclosing them by a circle in the narrowest point, appear as an immense **666, Mark of the Beast** and symbol of the **Antichrist**. Is it, perhaps, a challenge launched from hell toward heaven?

The number **33**, which expresses the angle at the vertex and the constant gradient of the line on the surface of the cone that generates the **3 spirals** of the 26 arcs of the "new church", coincides with the number **33** of the **degrees of the Freemasonry of the Ancient and Accepted Scottish Rite!** Moreover, the number **666**, formed of the **three spirals**, which represents the **Antichrist** and the **Mark of the Beast**, is, graphically, represented by the "**five-pointed Star**", which is the symbol par-excellence of **Freemasonry**.

The "**spiral-shaped**" form of the new church, besides expressing the idea of **god Satan-Lucifer** and the "**Pilgrim Path**", namely, the initiatic path and the objective which the "**Course of faith in Progress**" of Freemasonry tends to, namely, the "**Cult of Lucifer in full daylight**", conceals, perhaps, also the breeding ground and the promoting center of these impieties, and that is, the "**Masonic Temple**" constituted by the **33 degrees of the Freemasonry of the Ancient and Accepted Scottish Rite!**

¹¹ R.K. Spenser, "**The Cult of the All-Seeing Eye**", Omni Publications, pp. 17-18.

¹² Carlo Alberto Agnoli, "**La Rivoluzione francese nell'opera della Massoneria**", *The French Revolution in the Work of Freemasonry*, Ed. Civiltà - Brescia 1994, p. 134.

THE MASONIC TEMPLE

The freemason Jules Boucher, in his book, "Masonic Symbology", provides a singular representation of the Masonic Temple, composed of the 33 degrees of the Ancient and Accepted Scottish Rite: a "five-pointed star" inscribed into a "six-pointed star", and the whole he calls: "the hexagram with the pentalpha" or "Pentalphic-Hexagram". Boucher explains this symbology thus:

«Ragon poses this question: "What does become of the individual after death?" And he replies: "From effect that he was, he in turn becomes cause (...) since (...) his soul, which was not a particle of the universal soul, returns to this immense source of life, the 'Middle Chamber', the image of the great laboratory in which these infinite transformations are performed". (...).

"The Middle Chamber", writes Marius Lepage, is the loss of the illusions (...), it is the hermetically sealed athanor in which the glorious transmutation of the



Fig. 109. - L'Esagramma col pentalfa.

The hexagram with the pentalpha.

"The hexagram with the pentalpha", in Masonic symbology represents the "Masonic Temple" of the 33 degrees of the Ancient and Accepted Scottish Rite and its bond, through the number 11, with the Hebrew Kabbalah. The Masters' Lodge, or "Middle Chamber", wherein the Mason dies and then resuscitates as "Master" or "Disciple", is represented by the hexagon, which we highlighted in yellow, and which inscribes the "five-pointed Star".

centers of knowledge that pass from the brain to the heart, is fulfilled. The knowledge of the heart is the direct communication without a more or less opaque go-between, with the source of any life. It is the intellectual enlightening, before which all is shrunk to its appropriate dimension, it is erased and disappears; it is a reflection of the True Light, an echo of the lost word. (...).

René Guenon points out: "They say a Mason Master always stands between the Square and the Compass, that is, in the very "place" in which the Blazing Star is inscribed (five-pointed Star), and which is appropriately the "Invariable Middle". Hence (...) the Masters' Lodge is called "Middle Chamber".

With that, the Master is assimilated to the "true man", placed between Earth and Heaven and exercising the function of "mediator". (...) In all traditions, the "Middle" is the ideal center. To enter the "Middle Chamber" is to come to the center of the "Wheel", to the immobile



Fig. 107. - Squadra, Compasso e Stella Fiammeggiante.

(Square, Compass and Blazing Star)

"Masters' Lodge": represented by the area comprised between the Square and the Compass, wherein the "five-pointed Star" is inscribed.

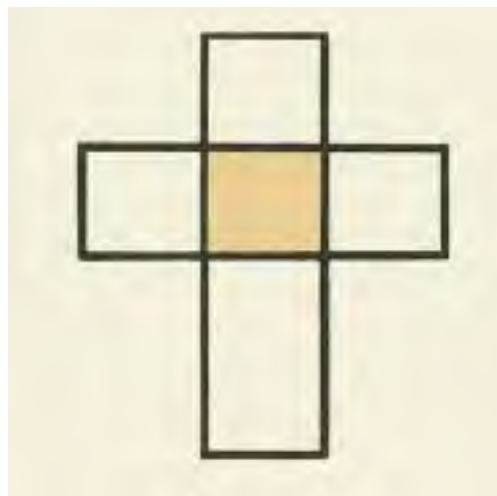

"Masters' Lodge": represented by the area of intersection of the two arms of the Latin-shaped Cross.

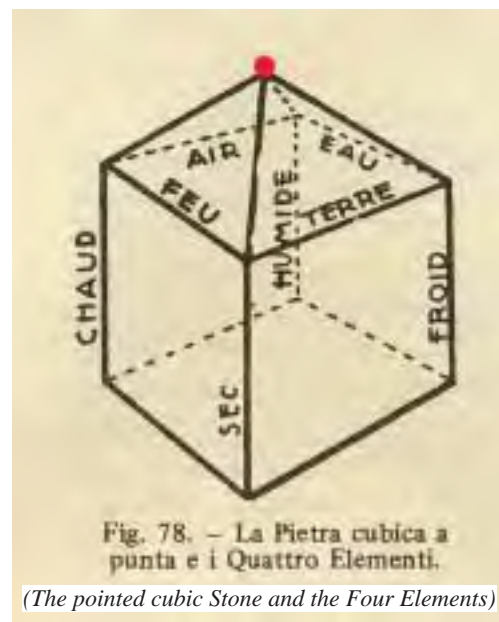

Fig. 78. - La Pietra cubica a punta e i Quattro Elementi.

(The pointed cubic Stone and the Four Elements)

"Masters' Lodge": represented by the summit of the pyramid that dominates a cube, which form the "pointed cubic stone".

axis (...). This image of the “Wheel” shows us the profane placed upon the circumference and the “Initiated” advancing on top of the beams, toward the Center where the velocity is nil.

The “Middle Chamber” is also the “Quintessence” of the alchemists, the point of intersection of the two arms of the cross, the summit of the “pointed cubic Stone”.

One comes to it by way of 15 steps divided into three groups: three, five, seven. These numbers are those of the (Entered) Apprentice, Fellow (Craft) and Master (Mason). Three is the Triangle; five, the Blazing Star; seven, the Seal of Solomon whose central point is man come to realize the perfect balance between Matter and Spirit. This “Seal of Solomon” is the hieroglyphic of the “Philosopher’s Stone”, whereas the Blazing Star (that is, the “five-pointed Star”) is that of the “Primal Matter”. The “Triangle”, or “Luminous Delta”, is the “Fire”, spiritual fire, intense, hidden with its action on the “Pentagram” or “Blazing Star” or “Primal Matter”, which leads to the “Hexagram” or “Seal of Solomon”, or “Philosopher’s Stone”.

G. Persigout, associating the “Seal of Solomon” and the “Blazing Star”, forms the figure he defines as the “Pentalphic Hexagram”. It is the union of the Microcosm with the Macrocosm.

It is interesting to note that the sum of 5 (pentagram) and 6 (hexagram) gives a total of 11. (...). Eleven is ten plus one, that is, the ten Sefirot plus En-Sof. And the 33 degrees of the Scottish rite can be divided into three series of eleven. (...).

The “Middle Chamber” can be compared to the hexagon enclosed within the hexagram. In this Chamber, Man, the Initiated, becomes Disciple.

The 6 triangles of the hexagram feature 18 sides; the 5 triangles of the pentagram have 15 sides. Adding up 18 and 15, we again come to the number 33.

The 15th degree of Freemasonry is the first degree of the “Chapters” and the 18th is the degree of “Rose-Cross”. This degree is but the amplification of the 3rd degree. It is 3 multiplied 6 (namely, 666 - author’s note).

The Master’s Lodge is called “Middle Chamber”, and must have two rooms for the initiations. (...). Until recently, the Temple used to be divided into two parts by a curtain. The first part was the Hikal, the second the Debhir. The Hikal is the room wherein Hiram dies, the Debhir that in which he resuscitates. (...). Hiram resuscitated! Such is the aim of the initiation to the degree of Master: the initiated becomes Disciple; he is beaming with Light.

(...).

Hiram resuscitated is the Master, he is the “True Man”. The Apprentice (raw Stone), following a phase during which he is “rough-hewn”, “acquires uniform faces” and becomes Fellow. These “faces” (cubic Stone) will be polished



Fig. 108. – Il Sigillo di Salomone col “centro”.

The Seal of Solomon with the “center”.

7 is the number of the “Master”, it is the Seal of Solomon with the central point; it is the “true man”, the “perfect Stone”, indispensable to the existence of the Masonic Lodge.



Fig. 9. – Il Pentagramma.

The Pentagram.

5 is the number of the “Fellow”, it is the Pentagram, or “five-pointed Star”, it is the “Primal Matter”, in order to arrive to the Seal of Solomon, to the Master, to the Philosopher’s Stone.

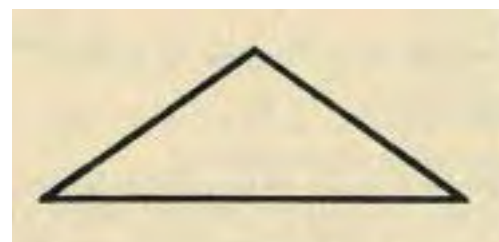

3 is the number of the “Apprentice”, it is the Triangle, or “Luminous Delta”, it is the “Fire”, the spiritual fire, intense, hidden that, with its action on the Pentagram, leads it to the Hexagram, that is, to the Master.

and will lose, by degrees, all their roughness. At last, the Master, in the fullness of his Masonic rights and of his duties, truly “identified”, will be an element, a perfect Stone in the Lodge, indispensable to the existence of the Lodge itself»¹.

This lengthy and dense citation of Jules Boucher provides us all we need to analyze and decipher the structure of the “new church”, and to discover the occult meanings hiding behind the symbology of the construction choices.

To sum up what Boucher stated, the representation of the Temple of the Freemasonry of the Ancient and Accepted Scottish Rite, in which the Mason fulfils his path as an Apprentice, Fellow and Master, has the following features:

- the number 11, which represents the mystic number of the Hebrew Kabbalah from which depend all the secrets and the symbology of Freemasonry;
- the number 18, again as “Mark of the Beast” 666 and as symbol of the “6-pointed Star”;
- being it a “church” of a Religion, there will have to appear a number expressing the Masonic ecumenism that aspires to reunite all the religions of the world, under the High Direction of Freemasonry;
- the presence of the number 6, as indication of the presence of a “6-pointed Star”;
- the presence of the number 5, as indication of the presence of a “5-pointed Star”;
- the number 15 again as a symbol of the “5-pointed Star” and as the 15 steps divided into three groups: 3, 5, 7, of the Apprentice, of the Fellow and of the Master;
- the geometrical conditions for their representation of the Masonic Temple described by Boucher;
- the number 33 also as sum of 15 and 18, when these represent the 5 and the 6-pointed Stars;
- the number 7, the number of the Master, as derivation of the “6-pointed Star” with the central point;
- that which, however, Boucher does not say, but which is key for the signature Freemasonry impresses to its works and enterprises, in addition to its known “5-pointed Star”, which is its symbol par-excellence, is that it usually conceals its special “Mark”: 3 times 666, as expression of its sole “dogma”: to declare and move war on God!

¹ Cfr. Jules Boucher, “La simbologia massonica”, *Masonic Symbology*, Atanor, Paris 1948, pp. 280-286.

Is this “NEW CHURCH” a MASONIC TEMPLE?

The “New Church” has been presented with these words: «There exists an inspirational line in the design of this church that acts as backdrop for the entire project of architect **Renzo Piano**: respect of the land and materials selection. The church will not “scar” the mountain with daring spires and perforations in the rock; the seashell-shaped structure seems to lie down on the ground, following the grave rolling of the hills of the Gargano region». «The floor-plan, in fact, opens out fan-like or, rather, like the profile of a seashell segmented into three portions that could contain up to **7,200** faithful». Says **Renzo Piano**, as the works are nearing completion: «I’m happy more than I’m satisfied. I’m not sure I’ll be taking on other similar projects; **this has been such an emotionally intense experience that I’m not sure I wish to repeat it**, as I fear the next would not be as nearly intense. And, besides, it’s not really important for an architect, once a church has been made, to make many more... **It is more fulfilling to discover these things**». That is exactly what we intend to do, too!

Let us represent the floor-plan of the **26 arcs of the church structure**, orienting it Eastward, as demand our churches that see in the rising sun, the Light, the symbol of **Our Lord Jesus Christ**, but also as require the **Masonic temples**: «The three windows are thus positioned: **the first, facing Eastward**; the second,

¹ Cfr. Jules Boucher, “**La simbologia massonica**”, *Masonic Symbolology*, Atanor, Paris 1948, pp. 157-158.

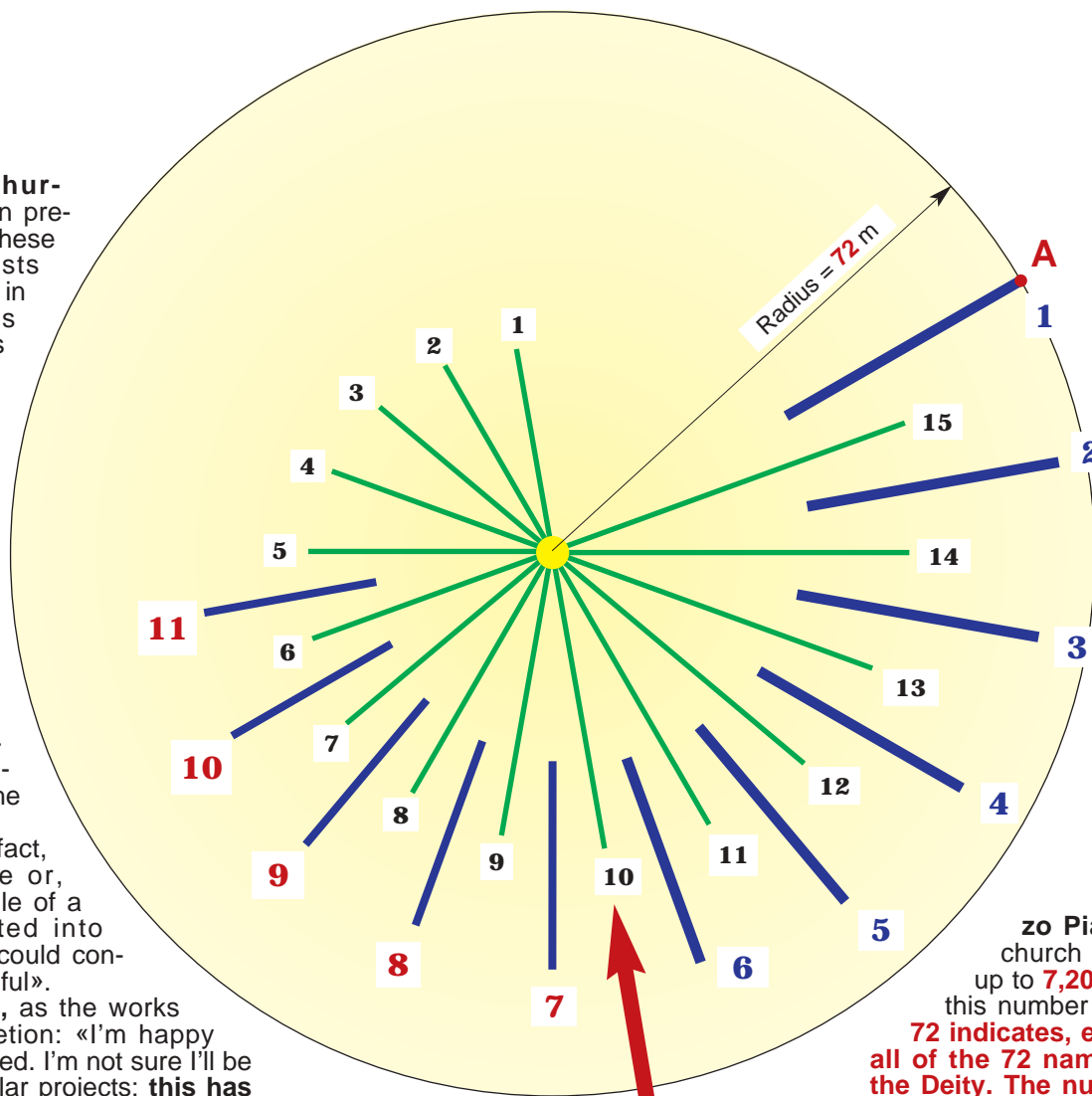

Entrance of Liturgical Aula

Southward; the third, Westward. (...). The Mason builders have always oriented their temples **with the entrance to the West**¹.

- The arcs that form the outermost spiral number **11**.
- The arcs, both external and internal, have an angular distance of 20°, and that is, a round angle divided into **18** parts. The number **18** represents all the segments of the “**6-pointed Star**” and, what is more, being the sum of **three 6**, it represents the “**Mark of the Beast**” **666** of the Apocalypse.
- The radius of the circle, which circumscribes the church’s structure, and which coincides with the outermost point of the first arc measures **72** meters. **Ren-**

zo Piano told us that the church could accommodate up to **7,200** faithful. What does this number mean? The number **72** indicates, ever since antiquity, all of the **72 names of the Name of the Deity**. The number **72**, therefore, is the number of **Masonic ecumenism**, which wishes to merge all religions, including the **Catholic Religion**, into the **secular, philosophical, scientific, Universal Religion of Gnosticism**, under the direction of the echelon of Freemasonry. It must be noted that **72** is the sum of **66** plus **6**, hence it derives from the “**Mark of the Beast**” **666**.

Maurizio Oddo, in “**La chiesa di Padre Pio a S. Giovanni Rotondo**”, *St. Padre Pio’s Church at St. Giovanni Rotondo* (p. 53), warns us: «Although dedicated to the holy, **the complex** (the “new church”) **is suitable to host inter-religious gatherings...**».

- The Entrance to the Liturgical Hall divides the **11** outer arcs into two groups: the first is made up of **6** arcs.

² R.K. Spenser, “**The Cult of the All-Seeing Eye**”, *Omni Publications*, pp. 32-34.

- The second group numbers **5** arcs. The numbers **6** and **5**, indicating the two Stars with **6** and **5** points, are present in many places and details of the "new church": the arcs with sectors of 6 and 5 blocks from the outside to the inside, in the details of the tiles, in other works, etc.
- The group of inner arcs is **15**, as the total number of segments of the "**5-pointed Star**" and as the **number of steps** to climb to the "**Middle Chamber**" or "**Masters' Lodge**".
- We obtained the number **33** from the **two 3° angles** of the cone that generates all the arcs of the structure of the "new church". In addition **33** is the sum of the numbers **15** and **18** already identified.
- At this point, let us trace a circle with a radius of **72** meters; let us subdivide it into **18** equal parts and, starting from point **A**, let us trace the lines of the "**6-pointed Star**". The "**5-pointed Star**", with the point facing upward, must be traced only after giving a **thickness to the "6-pointed Star"** in order to keep with the symbology illustrated by **Boucher**. Such a thickness is given, geometrically, by the inner extremities of the **2nd**, **3rd** and **4th** arc of the outer series and, after measuring it, it turns out to be of **42** decimetres. It must be noted

that **42** is: $6 \times 6 + 6$, hence it derives from the "**Mark of the Beast**" **666**. In addition, "one of the **72 Divine Names** has **42** letters". The number **42**, besides, has to do with the number **9** and with **Hell**, as "The Egyptian Pantheon had **9 Sun Deities**, whose head was **Osiris**. He was the **great Deity of Hell**, and it was universally believed that, right after death, the soul were judged by **Osiris**, in the presence of **42 Demons**, the "**Lords of Truth**" and the "**Judges of the dead**"².

Let us now trace the second "**6-pointed Star**" inner to the previous one with a distance of **42** decimeters and, with much accuracy, let us inscribe into the inner hexagon, the Masonic "**Middle Chamber**" or "**Masters' Lodge**", the "**5-pointed Star**" with the point facing upward. Because the two lower vertexes do not coincide with the two lower vertexes of the hexagon, there results that the **center of the "5-pointed Star" does not coincide with that of the "6-pointed Star"**. The distance between the two centers generates the **radius of the cylinder-shaped central pillar** supporting the central extremities of the 15 inner arcs.

- At this point, let us trace the **circle of the central pillar** and, in so doing, there appears the number **7**, as sum of the **6** sides of the "**6-pointed Star**" plus the unity represented by the center: and here you have the number of the "**Master**", of the "**perfect Stone**", of the "**perfect man**" indispensable to the existence of the "**Masonic Lodge**".
- The numbers **3** and **5**, corresponding to the (Entered) "**Apprentice**" (triangle) and to the "**Fellow**" (Craft) (5-pointed Star), are already contained in the constructed geometry.

What is still missing, and it is the most important thing, is the **special "Mark" of Freemasonry: 3 times 666**, as expression of its sole "**dogma**": **declaration of war on God!**

- The **first "Mark of the Beast" 666**, we have seen already with the three enormous spirals, traced on the extreme points of all the arcs of the structure, and observed from the "**depth of the abyss**".
- The **second "Mark of the Beast" 666**, we obtain from the "**6-pointed Star**" which, having a total number of **18** segments, represents **the number 18** that, being the sum of three **6**, forms the number **666**.
- The **third "Mark of the Beast" 666**, we obtain from the "**5-pointed Star**" which, in its meaning of **triple intertwined triangle** (see p. 59), to each of which corresponds the triple series of **11 (man God, Pontiff and King of himself)**, gives as total sum: $(11 + 11 + 11 = 33 = 6)$ which, repeated **three times**, provides the **third "Mark of the Beast" 666**.

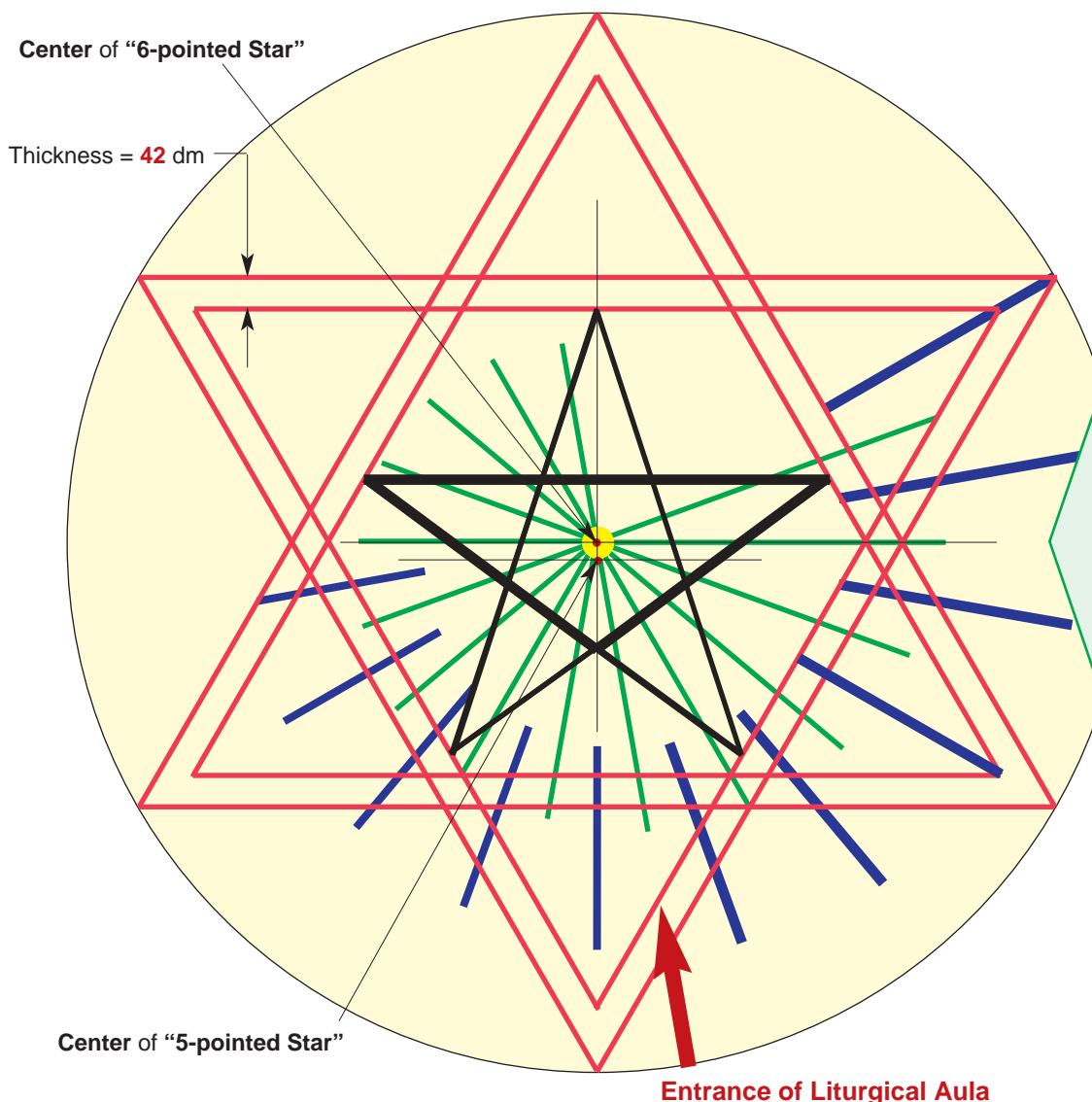

Universal axis:

in this geometry, the axis is that of the "**6-pointed Star**":
 The truth communicated to man by Lucifer is the "**divinization of creation**".
 The destruction of **Catholic Virtue**.
 It is the "**Cult of the Phallus**".
 It is the **temptation of Christ** in the desert: "**the pleasure**".
 It is "**the Godless man**".
 It is the scope of the **1st series** of the **11 degrees** of the Ancient and Accepted Scottish Rite.

“Triple Masonic Trinity”

- secret of this “New Church”? -

In the description of the ritual of the 31st degree of the Ancient and Accepted Scottish Rite, **Mons. Leone Meurin** comes across the oath of the Mason aspiring to that degree, whom vows obedience to the “**Holiest and Indivisible Trinity**” about which the Mason, however, receives no explanation.

A celebrated expert and scholar of the doctrine of Freemasonry, **doctor Eckert**, in his work “**The Temple of Solomon**” (p. 64), speaks at length of such **Triple Trinity**: «The matter of the world has existed throughout eternity, and shall exist for all eternity in **HOLY TRINITY**, that is, in the unity of three elementary matters: the masculine element of **Fire**, the feminine element of **Water**, and the neutral element of **Earth**. Prior to the formation of the universe, these elements mixed together formed the **Chaos**. The three primary elements, with the division of the **sexes into two**, give the **number five**, origin of every formation of the **Body of the world**, whose symbol is



«The center of the circle coincides with God itself. This point embedded into the Pentalfa, emblem of the initiated man, establishes the identity between man as he is being gnostically divinized and the god potentially dwelling inside of him. The triangle includes, in turn, man as he is being regenerated, to signify the Masonic domain in which it (the divinization) takes place».

(Epiphanius, cited work, p. 475).

the Sphinx, with the head and the breast of a woman, the body of a lion and the wings of an eagle. Developed by the force of the **Fire**, the elements produce, through the air, the **Soul of the world**, and through the **Light**, the **Holy Spirit**, whose symbol is the **Phoenix**, the **Flying Dragon** that rises from the fire, **Body, Soul, and Spirit of the world** form another **HOLY TRINITY** which embodies itself into the **Man-God**.

He, the **Architect of the Universe** with the **Patriarch of the World**, or Director of the spiritual Power, and with the **Emperor of the World**, or Director of the temporal Power, here you have the **HOLY TRINITY** inscribed on the supreme Cube of the Temple of Solomon.

The UPTURNED TRIANGLE, Lucifer, with the two crowned heads of the eagle, namely, the **Great Patriarch** and the **Great Emperor** or **Sovereign**, make up the “**HOLIEST AND INDIVISIBLE TRINITY**” which the Mason candidate to the 31st degree takes his oath of blind obedience to».



Image of the God-Serpent of the Gnostics: «We worship the serpent for God has placed him at the origin of Gnosis for humanity; he himself (the serpent) taught man and woman the complete knowledge of the lofty mysteries».

(Epiphanius, cited work, p. 22).



«The eye represented the mystical symbol of the so called **Egyptian Trinity**...».

(R.K. Spenser “The cult..”, p. 32).

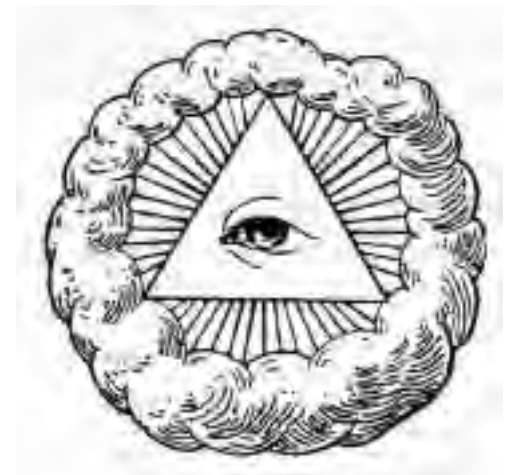

«The **sunburst patterned Triangle**, or **Triangle of Solomon**, is the symbol of the “**Great Architect of the Universe**”... soaring above the loathed and ignorant “**profane way**”.

(C.A. Agnoli, “La rivoluzione francese nell’opera della Massoneria”, *The French Revolution in the Masonic Work*, Ed. Civiltà, Brescia, p. 81).

“HOLIEST AND INDIVISIBLE TRINITY”

3rd “Blasphemous Trinity” of Freemasonry

From the structure formed by the 26 arcs of the “new church”, extracting the **up-turned Triangle** of the “5-pointed Star” with the **central Point**, and completing the 15 arcs, which depart from the center, on the entire circumference, one obtains the figure to the side: the representation of the Masonic “**Holiest and Indivisible Trinity**”.

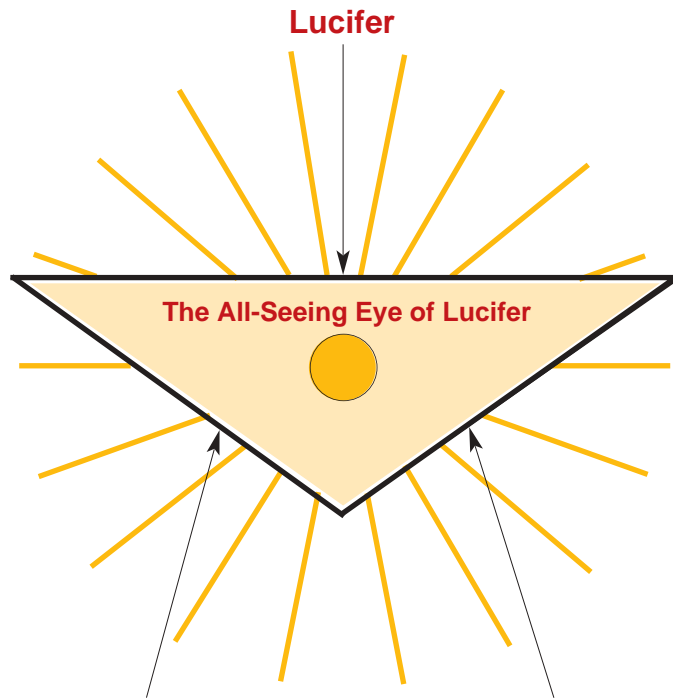

«This “**HOLIEST AND INDIVISIBLE TRINITY**” is represented by the **UPTURNED TRIANGLE** with the **central point: Lucifer**, with the **Patriarch of the World**, or **Director of the spiritual Power**, and with the **Emperor of the World**, or **Director of the temporal Power**».

The **18** beams, which correspond to the arcs of the church, completed upon the entire circumference, represent, with their number **18**, the “**celestial Perfection**”.

Patriarch of the World Emperor of the World

“HOLY TRINITY”

2nd “Blasphemous Trinity” of Freemasonry

From the structure formed by the 26 arcs of the “new church”, extracting the “5-pointed Star”, the “6-pointed Star” and the **central Point**, one obtains the figure to the side: the representation of the 2nd Masonic “**Holy Trinity**”.

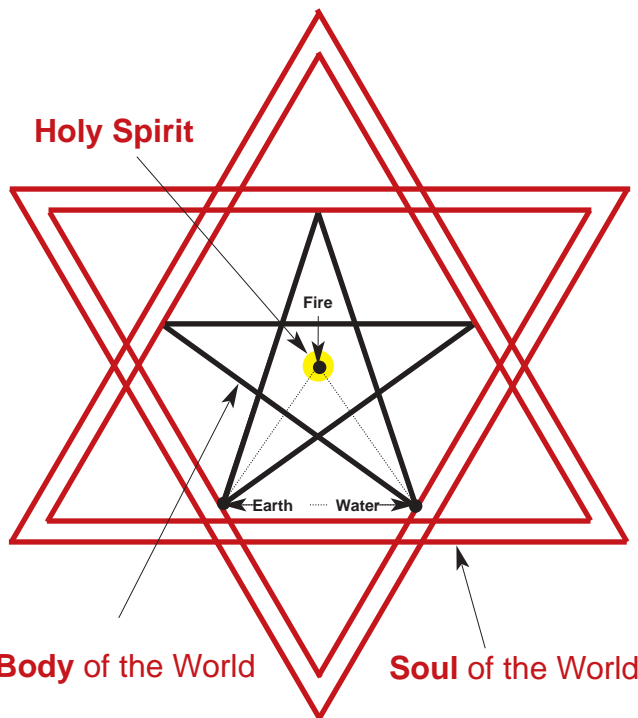

«Here is how the 2nd “**HOLY TRINITY**” is formed: the three primary elements, with the division of the **sexes into two**, give the **number five**, origin of every formation of the **Body of the world**. Developed by the force of the **Fire**, the elements produce, through the air, the **Soul of the world** and, through the **Light**, the **Holy Spirit**, whose symbol is the **Phoenix**, the **Flying Dragon** that rises from the fire. **Body, Soul, and Spirit of the world** form another “**Holy Trinity**” that embodies itself into the **Man-God**».

Body of the World Soul of the World

“HOLY TRINITY”

1st “Blasphemous Trinity” of Freemasonry

The Triangle, symbol of this “**Trinity**”, is formed by the two lower tips of the “5-pointed Star” with its center. It is the “**Primal Matter**”, the “**rough stone**”: it is the profane faithful that must be enlightened and molded into the Masonic “**perfect stone**”.

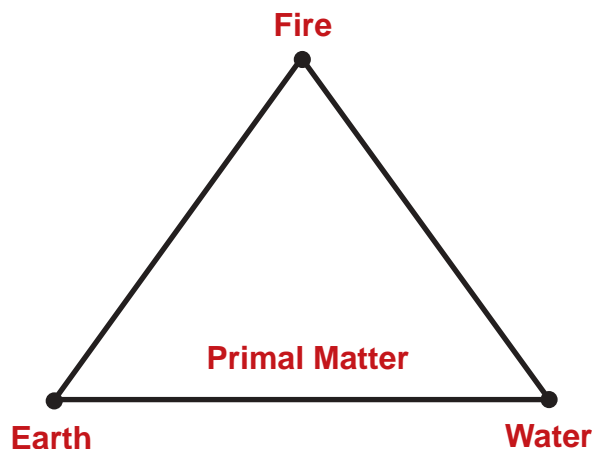

«This “**HOLY TRINITY**” is represented by a triangle facing upward: it is the **Matter of the world** that exists and will exist for all eternity, in the unity of three elementary matters: the masculine element of **Fire**, the feminine element of **Water**, and the neutral element of **Earth**. Prior to the formation of the universe, these elements mixed together formed the **Chaos**».

BRONZE DOORS

- ENTRANCE and BAPTISTERY

... for which Temple? -

The Liturgical Entrance and the Baptistry feature two bronze doors, work of the artist Mimmo Paladino: the right “large door” of the Liturgical entrance, and the left “small door” of the Baptistry. These two doors are the entrance to the Temple.

The official presentation of the symbology, carved on the two doors, is vague, fragmentary, and superficial.

The entrance to the “**Temple of Solomon**”, namely, to the **Temple of Freemasonry**, takes place at the 1st of the **33 degrees** of the Ancient and Accepted Scottish Rite, and its ritual corresponds to the “**Masonic Baptism**”.

Reads the ritual:

«The **Kingdom** which the **chosen Man**, the **future Mason** wishes to exit and above which he must elevate himself, is the profane world, the non-initiated humanity, sitting in the **darkness of ignorance** and **subject to the tyranny of the Kings and of the Priests**.

With the “**Masonic Baptism**” there is born a “**Son of Lucifer**”; as in the “**Catholic Baptism**” is born a “**Son of God**”.

The **Temple** has **3** steps and **2** columns: on the left, **Boaz**, the passive principle, material, feminine, evil; on the right, **Jachin**, the active principle, spiritual, masculine, and good.

The **Sacred Motto**, namely, the word that sums up the essence of the degree, is “**Boaz**”, which means stability, immobility.

The Candidate, nearly always a Christian (symbolized by a **sheep** of Christ) enters as “**Apprentice**” the 1st degree, which is dominated by the n. **3** and by the n. **2** of the 2 sexes expressing fertility and the “**Cult of the Phallus**”:

- **3** as the points of the **luminous Triangle**, **2** as the **Sun** and the **Moon**;
- **3** as the **3** stars of the Lodge and as the **2** stars of **Lucifer** and of the Candidate;
- **3** as the **3** windows of the Lodge;
- **3** as the **3** salutations of the Master;
- **3** as the **3** journeys of purification of the **Air, Water and Fire** and of the shedding of the **blood**;
- **3** as the **3** steps, the **3** knocks, the **3** kisses: the triple kiss, the **apron with the raised lapel** and the gloves “**destined to the woman whom he will love the most**”.

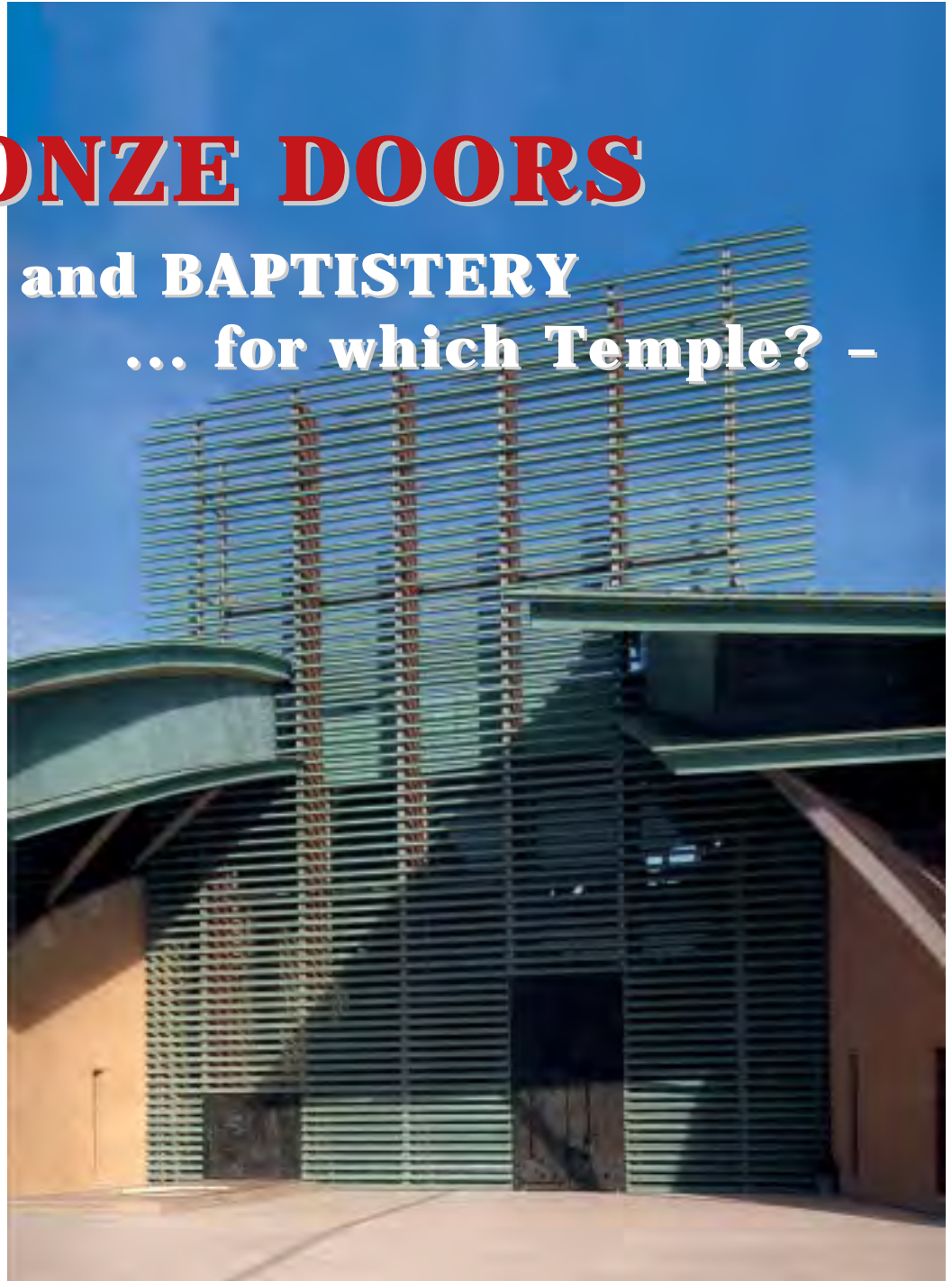

The façade of the **Liturgical Entrance** and of the **Baptistry**, with the two **bronze Doors**.

- the string with **12 knots**, or strings of love, on the column, called “**bubbola dentellata**”, (**toothed rattle**) which ends above the two columns of the Lodge, and which symbolizes the bond of the **12 tribes of Israel**; the **2** thick ribbons symbolize the vitality of the **2 tribes** that are still intact.
- the Candidate is asked **the alms** for the “**Widow and her children**” (Freemasonry and its Masons);
- the Candidate takes the **oath of obedience to the chiefs, in all they will command him** (the swords of the brothers are pointed to his breast, which thus resembles the **sun**, a complete imitation of the self-styled “**Infinite Sun**” of **Lucifer**. The tacit renewal of the oath is done by raising the right arm on the shoulder, **with the hand hanging down**.

The Candidate is now enlisted into the

great armada of the “**Apprentice Brothers**” that constitutes the **Primal Matter**, the “**rough Stone**”: the “**Body of the World**”, formed of the **3** elements of the 1st Masonic **Trinity**, with the **2** sexes, is symbolized by the “**5-pointed Star**”, which the “**Spirit**” must work upon.

The “**rough Stone**” from which the “**pointed cubic Stone**” that is necessary for the construction of the **Masonic Temple** is formed, constitutes the material origin, the **corporal element of man** to which must be associated a **Soul** (4th degree) and the “**Spirit**” (15th degree) the Mason will acquire by transforming himself into “**Master**”, or “**perfect Stone**”, or “**divinized Man**”.

¹ Leone Meurin s.j., Archbishop of Port Louis, “**Frammassoneria, sinagoga di Satana**”, *Freemasonry, Synagogue of Satan*, Siena 1895, pp. 269-278.



The **square** and the **compass**.

The **hammer**, the **chisel** and the **tracing table**.

The love **knots** that depart from a column cross the **square** and the **compass** and reach the other column.

The **Sun** and the **Moon** with the **7 stars** of the constellation of the **Ursa**.

The **2 columns J** and **B** (**Juda** and **Benjamin**) of the Masonic **Lodge**.

The **Temple of Solomon**, or **Masonic Temple** with the **3 steps** symbolizing the n. **3** of the **Apprentice** who dominates in the ritual of this degree.

Heraldic emblem of the 1st degree of the Freemasonry of the Ancient and Accepted Scottish Rite.

The "**Bubbola dentellata**" formed by **12 teeth** "ending above the **2 columns** of the Lodge".

The **3 stars** that form the **luminous Triangle** of the Lodge.

The **Candidate**, generally a **Christian**, at the 1st degree of "Apprentice".

The **12 love knots** (highlighted): symbolize the bond of the **12 Tribes** of Israel.

The n. **1, 2, 3, 4** symbolize: the **3 steps**, the **3 knocks**, the age of **30**, and the **Triple kiss**.

The numbers **1, 2, 3** the **3 parts** in which the **2 columns** have been divided, indicate the **3 steps** of the Temple of the Apprentice.

The Sacred Motto "**Boaz**" written in the Masonic alphabet.

The constellation of the **Ursa** with the **7 stars**.



The n. **11** of the 1st series of the **33 degrees**.

The **star of the Candidate**, pale reflection of that of **Lucifer**.

Symbol of the **raised Lapel** of the Candidate.

The **luminous 8-pointed Star**: the **Sun of Lucifer**.

The **Sun of Lucifer** is the **Sun** of the Lodge (the **Moon** appears in the Baptistry).

The **cup** of the "proof of the shedding of the blood".

The **shoe** symbolizes the **3 journeys** of the purification trials of the Candidate.



The **bronze door** of the **Liturgical Entrance**

The 1st of the **12 tribes** of Israel; the tribe of **Ruben**.

The "**Master**" of the Lodge directing the ritual of the 1st degree.

The tribes of **Simon** and **Levi**.

The **3 fingers** indicate, in this number, the essence of the 1st degree.

Bow with **12 leaves**, on each side, indicating the "thick ribbons symbolizing the vitality of the **2 tribes** that have remained intact".

The **2 tribes** remained intact: **Juda** and **Benjamin**: provide the initials of the two columns of the Masonic Temple, **J** and **B**.

The **2 columns of the Temple**, **J** and **B**.

The tracing **table**.

The **compass**, the **square**, the **hammer** and the **chisel**.

The **tribe** of **Ephraim** and **Manasseh**.

The **sheep** represents the Candidate, generally a **Christian**.

The **3 purifications** of the Candidate with the trials of the **air**, of the **water** and of the **fire**, with captions in the Masonic alphabet.

12 "5-pointed Stars", formed of **12 pentagonal base pyramids**: the flower (glove) to be "offered to the most beloved woman", symbolizing the **Trinity** that, with its **2 sexes**, forms the "**Body of the World**".





The Baptismal Fount

The Baptismal pool, of the shape of an **octagonal shell**, is one of the symbols of the **Moon**.

The **octagonal** shape of the Baptismal pool, with its **3** steps and the raised area, formed by **2 squares** of **342** cm side, underscores, with its dimensions, the theme of the “**magical Square**”, or “**Tetragrammaton**”, which, attributing **72 Names** to the **Name of the Kabbalistic God (Lucifer)**, symbolizes **Masonic ecumenism**, namely, the Masonic strategy of reuniting all religions under the direction of the High Initiates, **in order to suppress Religion and the Catholic Church**, the sole religion founded by God.

The 8-pointed Star

«At the top of the ladder, the “**8-pointed Star**” which - as **Oswald Wirth**, 33d degree of the Scottish Rite and recognized master of exoterism, teaches - **represents “Lucifer Carrier of Light”**, also called **Venus** in its appearance of **morning star... that, in the morning, wakes the sleepers, stirs the spirits from their torpor and incites to the Luciferian revolt against the existing dogmas**».

(Epiphanius, cited work, p. 197).



Noah's Arc

«The sacred knowledge, confined in the Temple, could not get out. It is contained in the **arc in order that is retain an esoteric sense and must not be communicated to all indistinctively**».

«The arc measures... Hence its shape of pyramid, of fire, of flame. **It contains the phallic energy**».

(Dictionary of Symbols, pp. 88-90).

The Fish

«The **fish** lives in water and **alludes symbolically to Baptism**».

«The **fish is symbol of fecundity** as well as **phallic symbol**».

«In astrology, the Fishes, twelfth sign of the Zodiac, **represent psyche, the inner world, gloomy, through which one communicates with the devil**».

(Dictionary of Symbols, pp. 204-206).

The Masonic Arc of Alliance

The **Masonic Baptism** of the 1st degree presupposes a **pact of Alliance** the Candidate must underwrite with his **oath of obedience**. The Masonic symbology of the figure reported above, clarifies the contents of this **Alliance**: the **15** steps of the ladder that rises skyward, lead to the “**Master**”, followed by **18** more (sum of the **15** plus the three that are made out) which gives **33**, to complete the course of the spiral and arrive to the “**8-pointed Star**” (**Lucifer**). The Arc unveils the numbers **3, 5, 7**, of the “**Master**” (**3** windows, **5** columns, **7** beams), and the n. **8** of the reinforcements of the planking of the Arc. The “**Tower of Babel**”, on the background, indicates

the “**Temple of Solomon**” (the Masonic Temple) that must be edified with the “**perfect stones**” of the “**Master**”. The impiety of the “**Tower of Babel**” is indicated by the **6** visible ways of the spiral that winds around its own axis, which is the “**Truth**” transmitted to man by **Lucifer**, symbolized with the **Star**, with the **Spiral**, with the numbers: **6** (ways of the Tower), **6** ($15+18 = 33 = 3+3$), **8** (8-pointed Star), **15** ($8+7$), **18** (666). The **Kingdom** in which the candidates to be initiated to Freemasonry must be “**fished**”, and above which the “**Master**” must raise, is represented by the **fish** of the sea. **The fish represent the Christian faithful**.

The Seashell

«With the Aztec, the **seashell** is the symbol of the **Moon god**, and it represents the feminine root and means **birth and generation...**».

«The **seashell... shares in the symbolism of fecundity...**».

(Dictionary of Symbols, pp. 309-310).

Symbol of the **Noah's Arc**: the **"Pact of Alliance"** with **Lucifer**. Hebraism and Freemasonry consider the Talmudic theory of the **7 Laws of Noah** as a link between **Judaism** and **Christianity**: the objective is **to give the Christian the same "God" worshipped by the Jews**, who refused the **Messiah**. The duplicity of these **7 Laws of Noah** (which should become the base of a **Code of Law for World Government**), is that **every Christian on earth could be executed as guilty of violating the 1st Law** (against idolatry) and the **2nd Law** (against blasphemy to God), for he believes in **Jesus-God-Incarnated**: which is **idolatry** and **blasphemy** to the Jews! The **7 Laws of Noah**, **"angular stone of a truly civil international legal order"** would constitute the **Religion of Humanity** of the **"faithful"**, whereas the Jews would be the **"priests"**, subject only, however, to the **Law of Moses** (Mosaism of Israel)!

The n. **17** = 9 + 8, which gives, by the product of 9 and 8, the number **72**.

The fish with the arrow points to the one at the bottom with the **Sacred Motto "Boaz"**.

"Master" fish, **"perfect cubic Stone"** symbolized by the numbers **3, 5, 7** and **666**.

16 teeth (notches) (right hand leaf to the observer); **4** fish (right hand leaf); **8** fish (left hand leaf); **17** teeth (notches) on left hand leaf; All these numbers indicate the **"Magic Square"** or **"Tetragrammaton"**, that is, they symbolize **Masonic ecumenism**.

The fish carries the **Sacred Motto "Boaz"** in the Masonic alphabet, which indicates the **1st degree**.

Symbol of the **"death to the profane world"** of the Candidate, in order to enter the **Masonic world**.

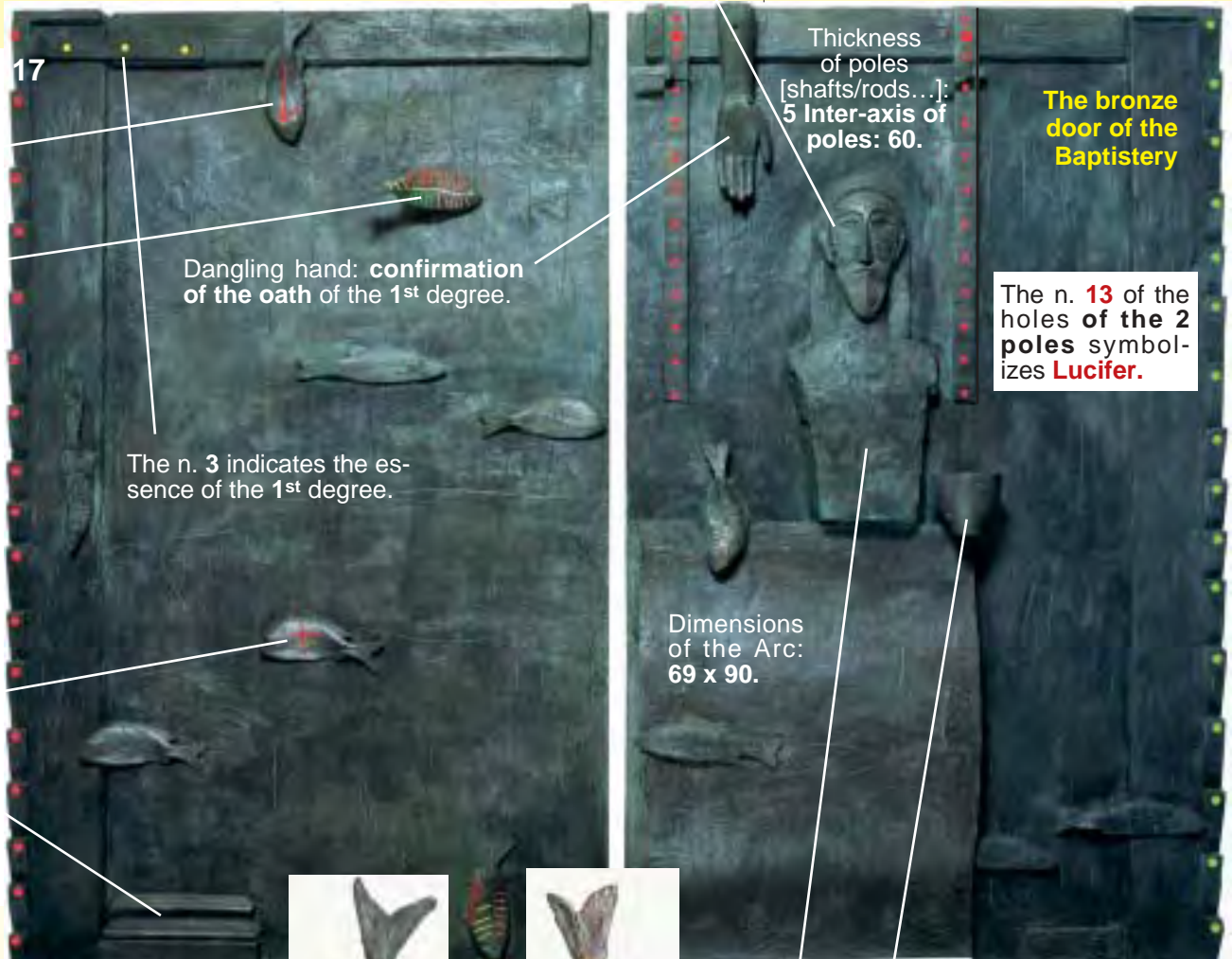

17

Thickness of poles [shafts/rods...]: **5** Inter-axis of poles: **60**.

The bronze door of the Baptistery

The n. **13** of the holes of the **2 poles** symbolizes **Lucifer**.

Dangling hand: **confirmation of the oath of the 1st degree**.

The n. **3** indicates the essence of the **1st degree**.

Dimensions of the Arc: **69 x 90**.



Fish with numbers (central sections) **3, 5** (4 + eye), **7** (3 + 4) of the **"Master"**, **6 x 3** (red and pink) = **18 = 666**
9 (left sections) x **2** (2 lines at the end of the 9 sections) = **18 = 666**.

Bowl for the Candidate's alms.

Noah symbolizes the **"Master"** of the Lodge presiding over the rituals of the **1st degree**.

Fish with the central cross that recalls the **"glorious cross"** with its **3 "cults"** (3 crossed sections at top); the numbers **3** (blue), **5** (red), **7** (green) indicate the **"Master"**.

Fish with the numbers **3, 5, 7** of the **"Master"**, **13** of **Lucifer**, **6** ("x" top) x **3** ("x" bottom) = **18 = 666**
9 ("x" top and bottom) x **2** (orange kins) = **18 = 666**.



Fish with the cross, but with the numbers **6** and **9** of the **Spiral = G.A.O.T.U.** and **6 + 9 = 15 = Degrees of the "Master" = 5-pointed Star = Freemasonry**.



Fish with the numbers **5** (horizontal sections on the right hand side), **6** (horizontal sections on the left hand side), **Point** (red on left side) which represent the **"5-pointed Star"** inscribed into the **"6-pointed Star"** with the **central Point**: the **2nd Masonic Holy Trinity** (cross), which embeds itself into the **"Master"**.



Fish with the **face of the "Master"** of the Lodge, with the numbers **6** and **5** = **"5 and 6-pointed Stars"** = Freemasonry, with the numbers **3, 4, 8, 9** of the **"Magic Square"**, which is the symbol of **Masonic Ecumenism**.



Fish with the numbers **3, 5, 7** (6 + eye of the fish) of the **"Master"**, (6 + 6 + 6) = **666** of the **Mark of the Beast** and of the **Antichrist**.

THE ALTAR



View of the altar, located atop two stairways each of 3 and 6 steps, under an enormous **spiral** unwinding over the 9 arcs of the structure of the **Liturgical Hall**.

«**T**he altar is wedged, for a certain length, into the bema; the bema is ripped open, **as at the moment of the resurrection**, in its whole of bronze at the base and **from this breach it (altar) soars**». «**It is the altar that rips open the bronze and causes to emerge, as stone, the Easter mystery**».

«That which, in the original idea, was the **glorious cross** on the altar, was becoming, as the work progressed, a sort of ciborium looming over the altar itself, and: **the altar could but be one sole work with “that” cross...**».

These are the words with which the **Capuchin Friars** introduce to us the **altar** and the “**glorious cross**” above it, in the work “**Pietre di bellezza e di santità**”, *Stones of Beauty and of Sanctity*.

The two stairways, which climb toward

the altar, feature **3** and **6** steps respectively. The number **3** times **6** gives **666**, which is the “**Mark of the Beast**” and the **Antichrist**.

Raising our gaze, above the center of the vault of the **9** arcs of the structure of the Liturgical Hall, an **enormous blue spiral** is observed. The spiral is the symbol of the **G.A.O.T.U.**, the **Great Architect Of The Universe**, the **God of Freemasonry**, better known with the name of **Satan** or **Lucifer**.

Turning our gaze around, one observes that all the arcs are formed by sectors of **6** and **5 blocks** that, indicating the two “**5** and **6-pointed Stars**”, in their whole (**15** + **18**), represent the **33** degrees of the Freemasonry of the Ancient and Accepted Scottish Rite.

The altar, with its rectangular base **reversed pyramidal shape**, is divided by

two **bronze bands** placed upon the axis of the base, and it is stuck into the “**bema**”, represented by a bronze rectangle placed on the floor and measuring **248 x 196** (cm).

In the whole of the numbers of all the dimensions characterizing it, the altar symbolizes the “**Magic Square**” or “**Tetragrammaton**”, which attributes **72 Names** to the **Kabbalistic Name of the God-Lucifer!**

As illustrated in the next page, the “**Magic Square**” is composed of **9** digits (from **1** thru **9**), located on the **9** characteristic points of the square, which invariably give the sum of **15**, in **3** digits, in the **8** directions.

The altar, divided by the two bronze bands, forms, with edges and intersections, the **9** characteristic positions of the “**Magic Square**” whereas the longer side

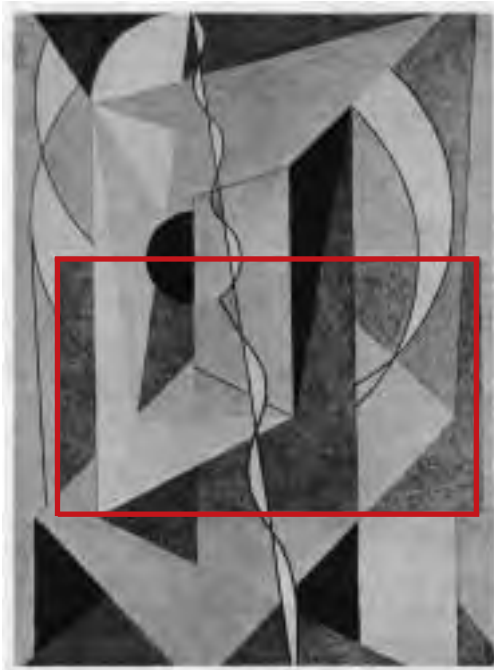

Mural fresco that covers the frontal wall of the **Meditation Room of the UN**; room where everyone goes to **worship his own God**.

In a study on the occult meanings on this place of prayer, with regard to the fresco, we read: «In its whole the fresco contains an asymmetric disposition that, in its occult meaning, leads to the **“Magic Square”** also called **“Tetragrammaton”**, composed of **9** cells, on **3** lines and **3** columns, containing the nine digits from **1** to **9**, where the sum of the three digits in the three horizontal lines, in the three vertical and in the two diagonal ones, always gives **15**... these **9** figures are considered sacred as the number **15** represents the numeric value of the Hebrew word of God, **JAH**, which is one of the forms of the **Tetragrammaton**...

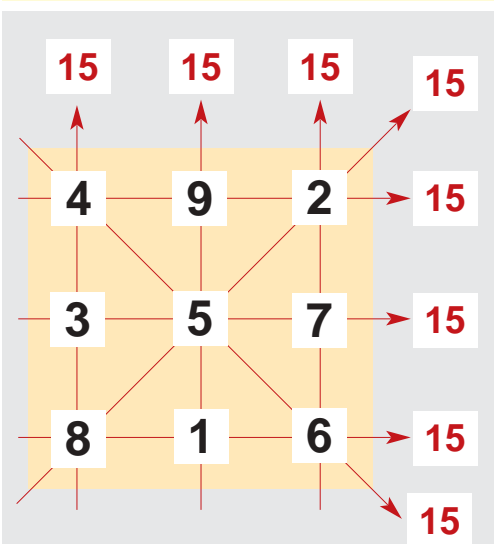

The **“Magic Square”** or **“Tetragrammaton”** is the sacred number **15** representing the Hebrew name of the God **“JAH”**, one of the **72 Names of the Kabalistic God**.

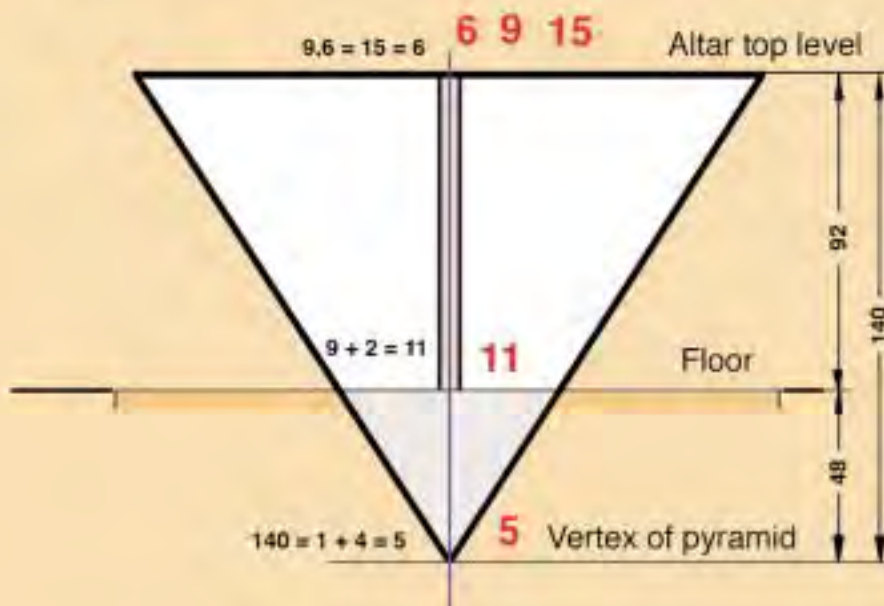
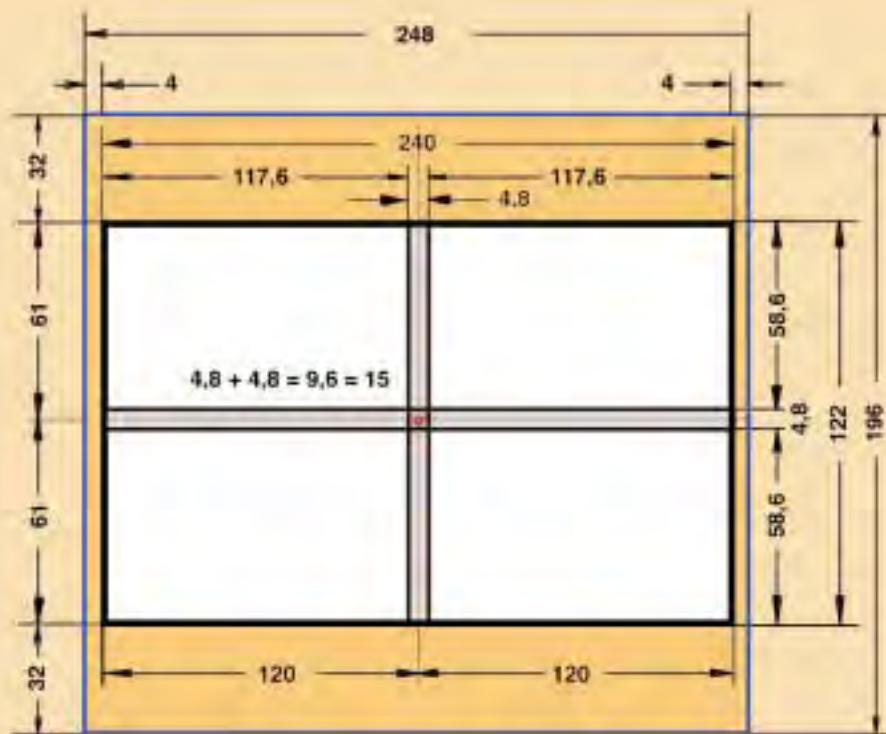

Drawing of the altar of the “new church”.

The rectangle - which we highlighted in red - **represents the altar**¹.

The **“Magic Square”** symbol of **Masonic ecumenism**, which wishes to merge all deities and religions, is characterized by **8** numbers **15** obtained as the sum of **3** numbers.

The altar, divided by two bronze bands, forms, with edges and intersections, the **9** characteristic positions of the **“Magic Square”** and the n. **248**, with the numerals **2, 4, 8**, “suggests” that there are **2** ways to obtain it. In fact, the heights of the drawing of the altar, give the digits from **1** to **9** of the **“Magic Square”**.

In addition, the side of the altar **240** contains **16** times **15**; the **4** heights, of

120 cm, in which its axis is divided, contain **8** times **15**; the sum of all the numbers of the **2** heights **117.6** give as sum **15**; finally, the sum of the two numbers **4.8**, thickness of the two bands crossing at the central point of the altar, give: **4.8 + 4.8 = 9.6 = 9 + 6 = 15**. The sum of the **15** obtained, is **8**.

What is the meaning of a similar altar? It is an altar dedicated not to the **God One and Trine**, and to His Son **Jesus Christ, Our Redeemer**, but it is dedicated to a **“God”** who has **72 names** and who is hiding under the symbols of all of these Names because **his real name is Lucifer!**

¹ Cfr. R. Keith Spenser, cited work, p. 15.



of the “bema”, measuring 248 cm, which represents the maximum height of all the dimensions of the altar, with the numerals 2, 4, 8, “suggests” that there are 2 ways to obtain the square (4) with its 8 directions. In fact, representing all the heights of the altar, one observes that are present all the digits from 1 to 9 of the “Magic Square”.

In addition, the major side of the altar, measuring 240 cm, contains 16 times 15; the 4 heights, of 120 cm, in which it is divided by its own axis on the two long sides, contain 8 times 15; the sum of the numbers of the 2 heights of 117.6, is 15; finally, the sum of the two numbers of 4.8, thickness of the two bands that cross in the central point of the altar gives: $4.8 + 4.8 = 9.6 = 9 + 6 = 15$. The sum of the numbers 15 obtained, is 8.

What is the meaning of this altar? It is an altar dedicated not to the God One and Trine, and to Our Lord Jesus Christ, but one that looks up to a “God” that has 72 names and that hides himself under the symbols of all these Names for he cannot yet show himself with his real Name, and must remain hidden in the darkness of the “Mysteries” of the high degrees of Freemasonry, waiting for his cult to be manifested to the public.

The direction that leads us to this “God” is that of the axis of the altar. Setting out from its vertex “stuck” into the “bema”, one discovers the number 5 ($140 = 14 = 1 + 4 = 5$); the point in which the altar emerges from the “bema” lies at a 92 cm distance from the base of the pyramid: $9 + 2 = 11$; the central point of the altar, where the axis of the pyramid intersects the plane of the “Table” of the altar, where the two bands cross, has the numbers $4.8 + 4.8 = 9.6 = 15$.

Now, the n. 5 symbolizes the “5-pointed Star”, symbol par-excellence of Freemasonry; the n. 11 is the mystic number of the Hebrew Kabbalah, (Jewish Freemasonry), source of all the symbols and of the mysteries of Freemasonry; the numbers 9, 6, 15, as already seen, symbolize Lucifer.

One needs to ask oneself: what does all this have to do with the Priest celebrating the Mass on this altar?

To answer, one must not limit oneself to the contents of the “manifested” symbology, that is, to that visible to the eyes of the non-initiated, but especially to that “non-manifested”, which “unveils” the entities of the “real power” and their “Mysteries”.

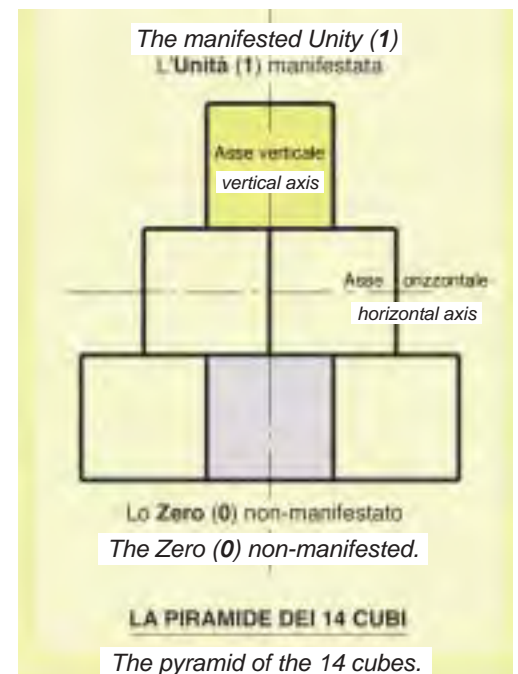

The pyramid of the 14 cubes placed on 3 levels: 9, 4, 1. The cube at the vertex is the manifested Unity (1), whereas the dark central one is the non-manifested Zero (0) (occult but more important) that is precisely opposite to the manifested one.

The freemason and expert of Masonic symbology **Joules Boucher**, writes: «**The altar** of the Egyptian temples was formed by a pyramid with “three cubes placed on top of one another...”».

The altar, the pyramid and the cube, in Masonic symbology, lead to the symbology of the “**pyramid of the 14 cubes**”, formed by 3 levels of 9, 4 and 1, cube at the vertex, where the only cube that is not visible (the “non-manifested”) is that central to the 9 of the first level, and opposite to the cube located at the vertex of the pyramid.

In other words, the cube at the “**vertex**” of the pyramid, the “**visible**” or “**manifested**” one, is much less important of the hidden one, namely, the “**non-manifested**” one.

Hence the pyramid of the altar tells the initiate he must make use of the “**inversion game**” of the pyramid, of the 14 cubes.

Now, let us start from the manifested “**vertex**”, that is visible to our eyes, when looking at the altar: the **Priest celebrating the Mass**. He stands at the vertex of a pyramid, identical to that of the altar, but with the base resting on the floor. The upper part of the pyramid is a triangle that encloses the thoracic part of the Priest. This represents the so called “**Moral Triad**” of the divinized Man of the Kabbalah, namely, the “**Masonic priestly activity** of promoting and inculcating the “**Cult of Man**” into the profane world (us poor Christian).

Inverting this pyramid, that is, passing to that of the altar, the vertex hidden and stuck into the “**bema**” is the “**non-manifested**” entity: this “**Triangle**” represents the **High Degree of Freemasonry**.

Observing the altar and the “**glorious cross**” above it, from a certain distance in front of the altar, one discovers that the sharp point of the highest “**nail**” of the cross forms a pyramid with the farthest points of the first step of the altar: a perfect equilateral Triangle.

Inverting this triangle, reversing it with the base on the line that almost touches the horizontal arms of the “**glorious cross**”, one obtains another equilateral triangle, with the tip turned downward, which (tip) contains the triangle “stuck into the bema”, which represents the **High degree of Freemasonry**.

The “**non-manifested**” entity obtained reversing this vertex, is contained within the vertex triangle that identifies the lateral arms, the central zone and the upper arm of the “**glorious cross**”.

The pyramid, with vertex at bottom, represents another “**Altar**” on which the High Initiated pay religious respect to their “**God**”. The upper arm of the cross, as we will analyze in the following pages, symbolizes the **God of Freemasonry: Lucifer**.

The two crossed equilateral triangles, however, form a “**6-pointed Star**”. Joining, now, the characteristic points **A**, **B** and **C**, created by the intersections of the axis of the altar and of the two inclined sides of the pyramid with base on the floor, with the hexagon internal to the “**6-**

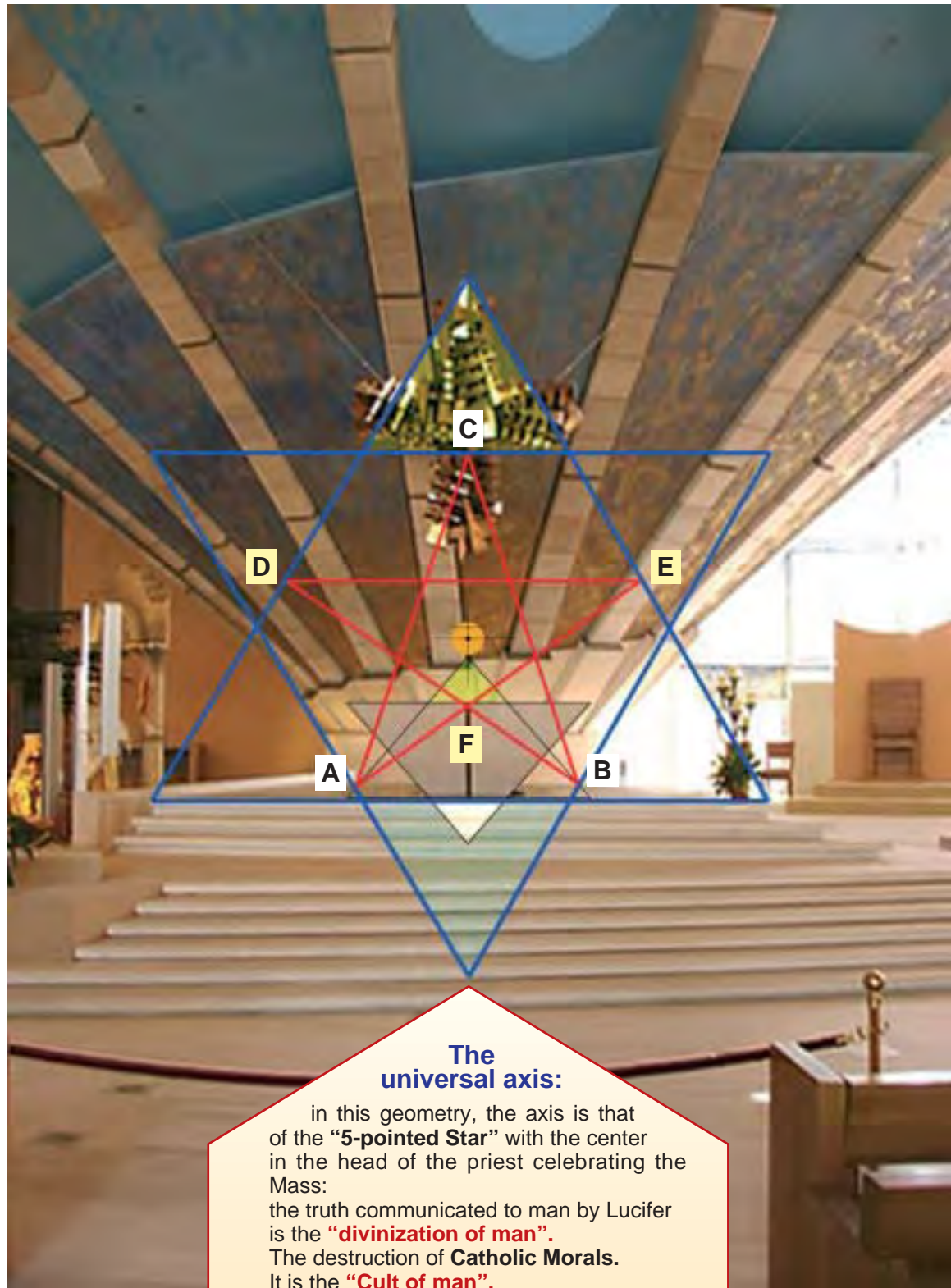

The universal axis:

in this geometry, the axis is that of the “**5-pointed Star**” with the center in the head of the priest celebrating the Mass:

the truth communicated to man by Lucifer is the “**divinization of man**”.

The destruction of **Catholic Morals**.

It is the “**Cult of man**”.

It is the **2nd temptation of Christ** in the desert: “**pride**”.

It is “**man who makes himself God**”.

It is the aim of the **2nd series of the 11 degrees** of the A.A.S.R.

pointed Star”, one obtains the characteristic Triangle **ABC** with base and vertex angles of **72°** and **36°** respectively, which define, in an univocal manner, a “**5-pointed Star**”, whose center is represented by the head of the **Priest**, which is also the **central point** of the Triangle **DEF**, but **NOT of the “6-pointed Star”**. The **Axis of the World**, or **Axis of the Spiral**, or **Universal Axis**, of this geometry, represents the “**Truth**” which **Lucifer** communicates to his disciples: **The DIVINIZATION OF MAN**, namely, man whom, having completed his “**course of faith**”

of the spiral, from one degree to the next, up to the **15°** of the **2nd series of 11 degrees** of the Ancient and Accepted Scottish Rite, becomes “**Master**”, “**perfect Stone**”, “**Mason Priest**”, “**divinized man**”. That is to say, having relinquished all bonds with the supernatural, and having assimilated the “**Cult of Man**”, he spreads this very cult among the ignorant Christian profane.

¹ Cfr. Jules Boucher, “**Masonic Symbology**”, Atanor, Paris 1948, pp. 164-165.

THE “GLORIOUS CROSS”

«**A**rnaldo Pomodoro, one of the greatest contemporary artists, had been asked a **bronze cross**, attached to the altar, which would represent the **five wounds**, but the artist was in quest of an idea that would be in harmony with his *modus operandi*...».

The **Capuchin Friars**, in their work “**Stones of Beauty and Sanctity**” inform us that the «Work was contracted to **Arnaldo Pomodoro**, whom, before commencing his work, **had to study the general project of the church**.

In concurrence with the architect **Renzo Piano**, with the **Capuchin Friars** and with **Monsignor Valenziano**, the master set out to work **supplying various drawings**».

One of these drawings of the cross was published by “**Luoghi dell’infinito**”, *Places of the Infinite*, magazine of September 1998, at page 22, in which **Arnaldo Pomodoro’s** style is so defined: «**a style that is primordial, mythical, essential, ancestral**. A style that refers to the sense of the holy as “**tremendum**”, **mysterious attraction of the hidden energies of the earth**». The article goes on to quote **Pomodoro’s own words**: «**The cross is a beautiful symbol... it’s the quintessence of abstraction and, therefore, of spirituality**».

Then, again, it reports the reflection of this **lay man**: «**Some, when in difficulty, turn to praying**; as for me, if I’m assailed by anguish, I **rush to my study and plunge myself into work**».



The “*Glorious Cross*” above the altar.

wherein it is paid **the religious respect to God: the act of cult**.

The absence of the Crucifix on this cross and its form with nearly equal arms induces to think not as much to the **Mystery of the Incarnation** and of the **Passion of Jesus Christ**, as to another kind of “**Mystery**”.

After an accurate study on the symbols that appear on the **5 parts** in which the cross is divided - the **4 arms** and the **area of their intersection**, which we have seen already to represent the “**Masters’ Lodge**” - the “**Mystery**” becomes clear and the “**Cult**” paid to the **Deity** appears in all its

lucid formulation in the three different cults:

- The “**Cult of the Phallus**”;
- The “**Cult of Man**”;
- The “**Cult of Lucifer**”.

The “**Cult of the Phallus**”, animating the **1st series of 11 degrees** of the A.A.S.R. and leading to the “**Godless Man**” and to the elimination of **Catholic Virtue**.

The “**Cult of Man**”, animating the **2nd series of 11 degrees** of the A.A.S.R. and leading to the “**Man who makes himself God**” and to the elimination of **Catholic Morals**.

The “**Cult of Lucifer**”, animating the **3rd series of 11 degrees** of the A.A.S.R. and leading to the “**Man who fights God**” and to the elimination of **Catholic Authority**.

Hereafter, are detailed the symbolic contents of **this drawing** of the cross.

As it was impossible to analyze this “**glorious cross**” in its actual construction, I limited my analysis to the drawing executed by **Arnaldo Pomodoro** and published on the cited magazine, “**Luoghi dell’infinito**”, *Places of the Infinite*.

As the drawing is only bi-dimensional, it has the advantage of highlighting all the symbols the artist had etched on this cross. Such symbols, however, are not to be taken as separate entities with respect to one another, but, as in a mosaic, **what is essential is the unitary idea these symbols are able to convey** in the wholeness of the work of art.

It is precisely this **unitary idea** to appear, in all its evidence, in this cross.

The cross dominates the altar, the place

The symbology of Freemasonry

In order to conceal its **"truths"**, Freemasonry makes use of different types of symbology: operative, geometrical, numerical, chromatic, astronomical, mineral, vegetable, animal, alphabetic, biblical, heraldic, alchemic, cultural, mythological.

To represent the **"message"** of the **three "Cults"**, conveyed by the **drawing of the cross**, were used:

1. the **"Apron"** of the **"Master"**;
2. the **heraldic Emblem** of the **11th degree**;
3. the **heraldic Emblem** of the **22nd degree**;
4. the **heraldic Emblem** of the **33rd degree**;
5. the **representations of Lucifer**.

Are these the **"5 wounds"** stricken upon **Jesus Crucified on the Cross**, which Pomodoro was supposed to represent?

The Baphomet



The "Cult of Lucifer"

This is the **"Cult"** of the **"Divinization of Lucifer"**, the God of Freemasonry. This leads to the replacement of the **Holiest Trinity** with the blasphemous Masonic **"Triple Trinity"** and to the replacement of **Christ on the Cross**, in Whose place it is placed **Lucifer**, who offers his own **"Redemption"** to the entire **"Divinized Humanity"**.

The **"Cult of Lucifer"** has been imprinted into the drawing of the cross, making use of numeric, geometric, alphabetic etc. symbology, to represent **Lucifer**.

The **"Cult of Lucifer"**, the **"inspiring principle"** of the **3rd series of 11 degrees** of the A.A.S.R., leads the Mason to **fight the Catholic Authority**, in order to replace it with the **Masonic Authority**, until it makes of him a **"Man who fights God"**.

In the upper arm of this cross, are represented various symbols representing **All the Names of the Kabalistic Name of God: Lucifer**.



33rd degree



22nd degree

The "Cult of the Phallus"

This is the **"Cult"** of the **"Divinized Creation"** of Freemasonry. This leads to the sacralization of the **sexual act** (in general of **"pleasure"**), which is regarded as a manifestation of the divine activity of **"creation"** (intended as **"generation"**).

The **"Cult of the Phallus"** has been symbolized by the **Apron of the "Master"** (carrying the letter **M** and **B**) for the **vile sexual significance** such apron represents to the "Apprentices", to the "Fellows", and to the "Masters".

The **"Cult of the Phallus"**, **"inspiring principle"** of the **1st series of 11 degrees** of the A.A.S.R., leads the Mason **to fight Catholic Virtue**, in order to replace it with the **Masonic Virtue**, until it makes of him a **"Man without God"**.

In the drawing of this cross, have been represented the operative symbols that appear on the apron of the **"Master"**.



11th degree

The "Cult of Man"

It is the **"Cult"** of the **"Divinized Man"** of Freemasonry. This leads to the sacralization of **Man** (and of his **"pride"**), regarded as the most independent being of the universe, and as carrying the **"divine spark"**, hence, as being divine himself.

The **"Cult of Man"** has been symbolized by the **3 degrees: 11th, 22nd, and 33rd** for the meaning these 3 degrees have: **man is "God" (11th)**, **"Pontiff" (22nd)** and **"King" (33rd) to himself**.

The **"Cult of Man"**, the **"inspiring principle"** of the **2nd series of 11 degrees** of the A.A.S.R., leads the Freemason **to fight the Catholic Morals** in order to replace it with the **Masonic Morals**, until it makes of him a **"Man who makes himself God"**.

In the three arms of the drawing of the cross: lower, right and left (looking at the cross) have been represented the symbols represented in the **heraldic emblems** of the three degrees: **11th, 22nd, 33rd**.



The **All-seeing Eye of Lucifer**, inside the **triangle**.



The word **G.A.O.T.U. (Great Architects Of The Universe)** (in italian **G.A.D.U.**), written in the Masonic alphabet, representing all **4 letters**.



The Baphomet



Left: the letters **D.M.I.** of the Motto of the **33rd** degree: **"Deus meumque Jus"**.

- The letter **D** (red);
- the letter **M** (blue);
- the letter **I** (yellow).



In the **heraldic Emblem** of the **33rd** degree, appear:

- a **2-headed eagle with a sword in the talons**: at the center (magenta) one observes a shape that seems to have **two wings**, one **head with a beak** and **two connected wedges** indicating 2 heads. The **sword** (red) crosses it;
- a **sword crossed with a rod of justice**: the long **sword** (red) with the tip of the **rod** (green) flanked by the **4 +1 wedges** symbolizing the **5 fingers**;
- a **9-pointed Star of 3 intertwined triangles**: toward the left, there appears a **triangle** (yellow) almost divided into three (point, lower left side area, and the rest) with **3 series of 3 interconnected wedges** (yellow).



The **33rd** degree is symbolized with the numbers:

- **33 wedges** (red), above;
- **6 and 5 wedges**, indicating the two **"5 and 6-pointed Stars"** ($15 + 18 = 33$);
- **3 + 3 wedges = 33**, joined by the yellow sword.



33rd degree

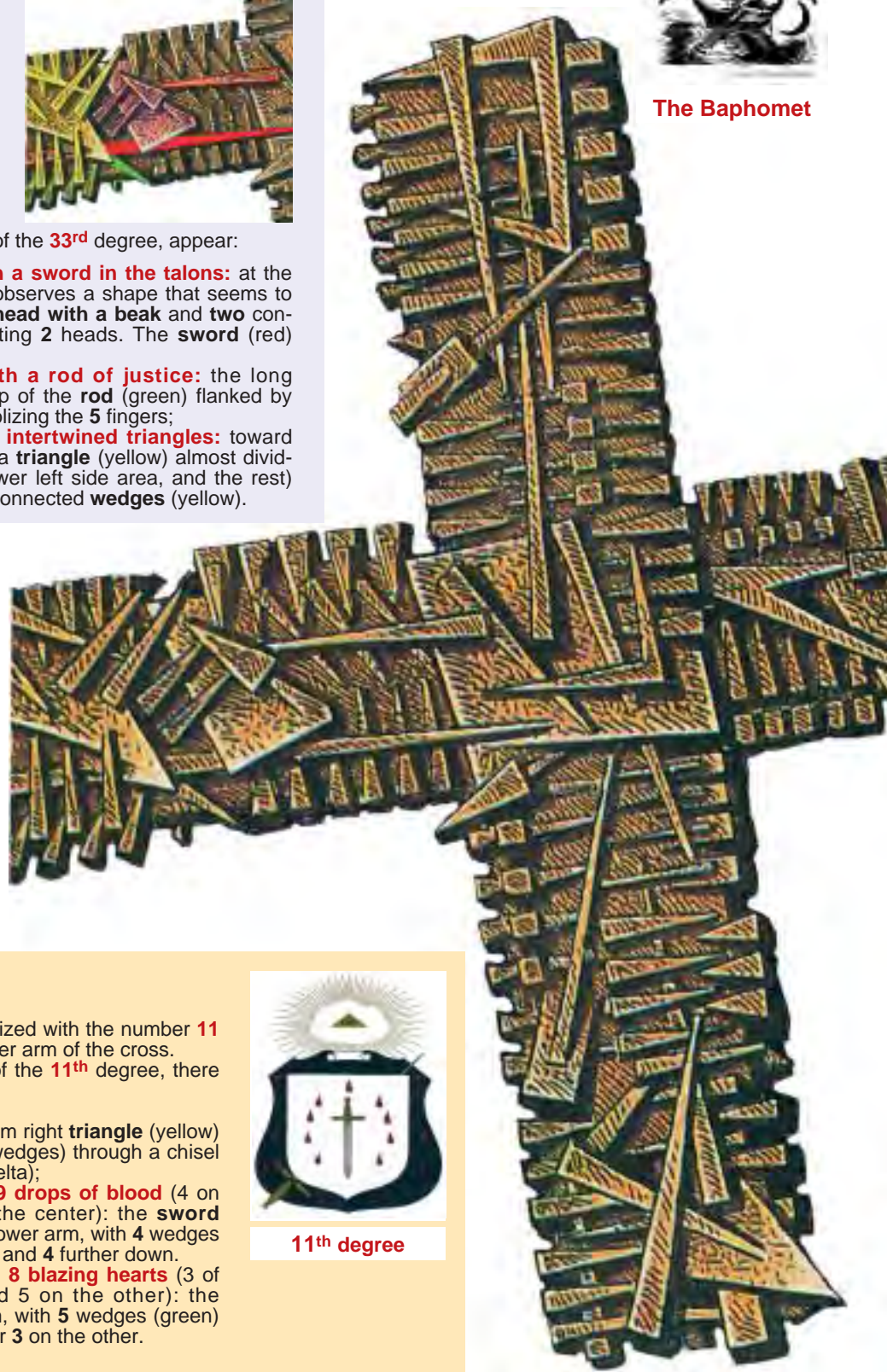

The **11th** degree is symbolized with the number **11** of the **hammers** of the lower arm of the cross. In the **Heraldic emblem** of the **11th** degree, there appear:

- a **magic Delta**: the bottom right **triangle** (yellow) linked to the n. **3** (blue wedges) through a chisel (used to carve out the Delta);
- a **straight sword with 9 drops of blood** (4 on each side and one at the center): the **sword** (purple) in axis with the lower arm, with **4 wedges** above, one at the center and **4** further down.
- an **inclined sword with 8 blazing hearts** (3 of which on one side and 5 on the other): the **sword** (green) at bottom, with **5 wedges** (green) on one wall and the other **3** on the other.



11th degree



The triple set of three of 6 wedges gives **666**: the "Mark of the Beast" and of the **Antichrist**.



Sickle and Hammer, are the symbol of **Lucifer** whose signature is the triangle (yellow).



The Greek symbol of **Christ**, but with the equilateral triangle (yellow) indicating **Lucifer**.

L'Alfabeto Massonico

L'Alfabeto massonico è stato pubblicato tante
spesso che possiamo ridarloqui. Eccone la chiave:

ab	cd	ef	
gh	il	mn	
op	qr	st	

Fig. 33. - Chiave dell'alfabeto massonico.

Le lettere sono le seguenti:

a	b	c	d	e	f	g	h	i	l	m	n	o	p	q	r	s	t	u	v	x	y	z

Fig. 34. - L'alfabeto massonico.

Le lettere k, j, v e w, che mancano, sono
sostituite da c, i, u.



22nd degree



The **22nd** degree is symbolized by the number of the **22** cuneiform objects of the right hand arm of the cross.

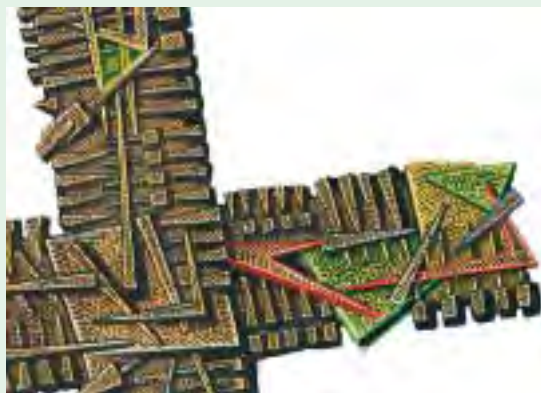

In the **heraldic Emblem** of the **22nd** degree appear:

- a **table**: under all of the objects and highlighted in green;
- a **compass**: on the left, highlighted in red;
- a **square**: on the right, highlighted in red;
- a **parchment**: under the square, highlighted in yellow;
- a **goniometer**: triangle on the parchment (light green);
- a **ruler**: above the square, and highlighted in blue;
- a **human eye**, on top of all: this appears in the upper arm of the cross inscribed into an equilateral triangle.



The Apron... of the "Master".



The letter "G" of "Generation" in the Masonic alphabet.



The **Eye of Lucifer** in the Triangle.

The letters "**M**" and "**B**" (written in the Masonic alphabet) of the Apron of the "**Master**" and the three numbers **3, 5, 7**, representing the "**Master**".

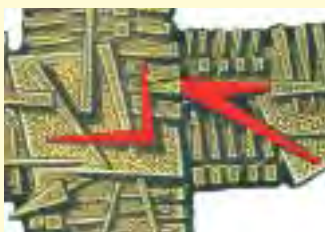

The symbols of the Masonic **Square** and **Compass**.



The letters "**M**" and "**B**" in the Masonic alphabet.



The n. **5** indicating the "**5-pointed Star**".



“Triple Masonic Trinity”

- secret of this “New Church”? -

In the description of the ritual of the 31st degree of the Ancient and Accepted Scottish Rite, **Mons. Leone Meurin** comes across the oath of the Mason aspiring to that degree, whom vows obedience to the “**Holiest and Indivisible Trinity**” about which the Mason, however, receives no explanation.

A celebrated expert and scholar of the doctrine of Freemasonry, **doctor Eckert**, in his work “**The Temple of Solomon**” (p. 64), speaks at length of such **Triple Trinity**: «The matter of the world has existed throughout eternity, and shall exist for all eternity in **HOLY TRINITY**, that is, in the unity of three elementary matters: the masculine element of **Fire**, the feminine element of **Water**, and the neutral element of **Earth**. Prior to the formation of the universe, these elements mixed together formed the **Chaos**. The three primary elements, with the division of the **sexes into two**, give the **number five**, origin of every formation of the **Body of the world**, whose symbol is



«The center of the circle coincides with God itself. This point embedded into the Pentalfa, emblem of the initiated man, establishes the identity between man as he is being gnostically divinized and the god potentially dwelling inside of him. The triangle includes, in turn, man as he is being regenerated, to signify the Masonic domain in which it (the divinization) takes place».

(Epiphanius, cited work, p. 475).

the Sphinx, with the head and the breast of a woman, the body of a lion and the wings of an eagle. Developed by the force of the **Fire**, the elements produce, through the air, the **Soul of the world**, and through the **Light**, the **Holy Spirit**, whose symbol is the **Phoenix**, the **Flying Dragon** that rises from the fire, **Body, Soul, and Spirit of the world** form another **HOLY TRINITY** which embodies itself into the **Man-God**.

He, the **Architect of the Universe** with the **Patriarch of the World**, or Director of the spiritual Power, and with the **Emperor of the World**, or Director of the temporal Power, here you have the **HOLY TRINITY** inscribed on the supreme Cube of the Temple of Solomon.

The **UPTURNED TRIANGLE**, **Lucifer**, with the two crowned heads of the eagle, namely, the **Great Patriarch** and the **Great Emperor** or **Sovereign**, make up the “**HOLIEST AND INDIVISIBLE TRINITY**” which the Mason candidate to the 31st degree takes his oath of blind obedience to».



Image of the God-Serpent of the Gnostics: «We worship the serpent for God has placed him at the origin of Gnosis for humanity; he himself (the serpent) taught man and woman the complete knowledge of the lofty mysteries».

(Epiphanius, cited work, p. 22).



«The eye represented the mystical symbol of the so called **Egyptian Trinity**...».

(R.K. Spenser “The cult..”, p. 32).

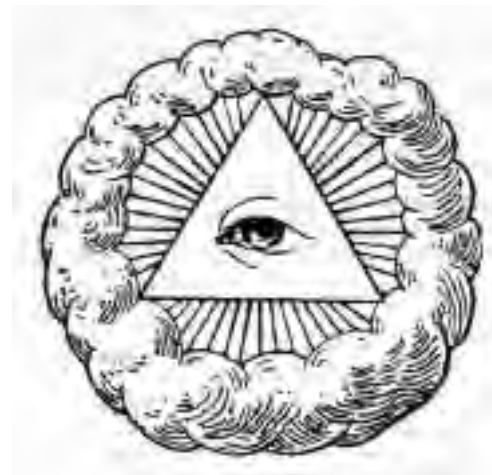

«The **sunburst patterned Triangle**, or **Triangle of Solomon**, is the symbol of the “**Great Architect of the Universe**”... soaring above the loathed and ignorant “**profane way**”.

(C.A. Agnoli, “La rivoluzione francese nell’opera della Massoneria”, *The French Revolution in the Masonic Work*, Ed. Civiltà, Brescia, p. 81).

the **TABERNACLE** of what God?

The Tabernacle is the abode of God. The symbols that adorn this holy home should not only be permeated with a spirit of sacred respect, of veneration and adoration, but, above all, they **should express the true essence of the concept of the God** who inhabits the Tabernacle.

We have already seen that the center of the **Tabernacle**, at **18** m. from the base, associated it to the **“Mark of the Beast” 666**.

The area surrounding the Tabernacle, besides, symbolizes the **Tetragrammaton** with its n. **15** and its claim to represent All of the **72 Names** of the **Kabalistic Name of God-Lucifer!**

The **“black Stone”** stele of the **Tabernacle**, moreover, is, ever



View of the square base black stone pyramidal stele of the Tabernacle.

since antiquity, a **pagan expression of the deity**; paganism of which **Freemasonry** is permeated and of which the echelon of the **UN** seem to be the confident assertors and eager propagators, even if, nowadays, merely making use of a symbology that hides the real contents of their doctrine from the profane world.

From the **“Schethya”**, the **“pointed cubic stone”** **“at the origin of the World”** (**Lucifer**), the **Altar** and the **Tabernacle** of idolatry have been called: **“cubic stone”**, **“angle stone”**, **“black stone”**, **“column Stone”**, down to the **“talisman”** of the **“Lucifer Trust”**. But the **UN** informs us that this **“black Stone”** is a **symbol that says how the Light of the Spirit gives life to the matter»!**

When the **Tabernacle is opened**, the **13th tile** disappears, making appear this 2-door silver closure, adorned with **two fish** facing one another.

The fish are notoriously **“mute”**, and such they remain to the profane, whereas to the initiates, their eloquence takes the form of **symbols:**



- **33** scales = Freemasonry;
- **5** vertexes of the fins = **“5-pointed Star”** = **15** = Freemasonry;
- **5 + 1** vertexes of the fins = **“6-pointed Star”** and of the n. **18**;
- the eye forms a **9** and a **6 = 15**;
- the numbers **3, 5, 7** (on the gills and on the tail) of the **“Master”**.

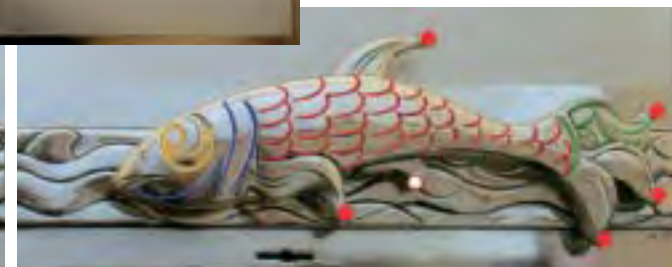

“BLACK STONE” ALTARS AND TABERNACLES

Speaking of the occult meanings of the **Meditation Room of the UN**, Spenser writes: «The altar is a block of crystal mineral of a dark gray color weighing 6.5 tons».

And he continues: «At a higher esoteric level, **the altar of mineral stone** recalls the ancient **Foundation Stone** once placed in the foundation of the **Temple of Solomon** and, later on, during the construction of the **second Temple**, transported into the **“Saint of Saints”**. It was of a **perfectly cubic shape** and had, inscribed on its upper face **inside a Triangle or Delta**, the holy **Tetragrammaton**, or **Ineffable name of God**».

Spenser reports the following citation of the work of **A.E. Waite**, **“The Secret Doctrine of Israel”**: «A mysterious stone, called **Schethya**, that was thrown by Jehovah into the abyss, so as to form the base of the world in order to give it life. One could think that it were like **an altar of cubic stone**, for its extremity was hidden in the deep, whereas its surface emerged above the chaos. It was **the central point of the immensity of the world: the angle stone**».

Is this about Christ-angle stone? - Spenser asks himself. No! Says he - **«because this has been discarded by the builders»!**

And he continues: «It is sufficient to walk into the **Meditation Room** at the UN to perceive the **absence of God in the UN**. The mineral **“stone”** of the altar, in its dismal and crude **construction is, in itself, a symbol of idolatry**.

The worship of stones is an ancient practice; Eusebius quotes Porphyry who said that **the ancient represented the Deity with a black stone**, on account of its obscure and inscrutable nature. The reader, at this juncture, may recall the black stone, **Hajar el Aswad**, located in the Southwest corner of the **Kaaba**, at **Mecca**, which the Arabs worshipped in antiquity...

The Druids, it is known, had no other image of their Gods than **stones in the shape of a cube or column**... which gave the idea of stability and strength - a symbol or idol of the same Deity... the god **Hermes** (Mercury) was represented without hands and feet, being a **cubic stone**, since the figure of the cube denoted stability and solidity».

«The description of the altar as **“natural talisman”** of the **World Goodwill** (the Group of the **“Lucifer Trust”**, then renamed **“Lucis Trust”**, the most powerful satanic sect of the world that rules the UN - author’s note), tells us that **“talisman”** is a term that means **“stone”**...

The altars, amongst the ancient, were made of **stone**... generally of a **cubic shape**. The altars were erected ahead of the Temples»¹.

¹ R. K. Spenser, **cited work**, pp. 8-15.



The **Tabernacle** is a pyramidal stele of lavic **black stone** of Mount Etna, **3.5** meters high, with a **square** base of **9** decimeters in side ending at the top with a **regular octagon**, and resting upon an **octagonal** base marble base.

The **“Dictionary of Symbols”**, at the call **“seven”**, among others, reads: «So, the infernal Beast of the Apocalypse has **7 heads**. But the seer of Patmos (St. John Evangelist) **often reserves to the evil powers the half of 7, which is 3.5**, thus highlighting the failure of the enterprises of Evil»¹.

If the two lines connecting the two vertexes of the **9 dm** base with those of the frontal side of the octagon are continued, at the top of the stele, one comes to the height of an isosceles triangle of **6 m**. **The number 6**, in the Bible, **is the number of the impious**. This number, however, re-proposes the theme of the numbers **6** and **9** as beginning of the **spiral**, symbol of the **G.A.O.T.U.**, namely, of **Satan, Lucifer**. In addition, the sum **6 + 9** gives **15**, numerical value of the word of the Jewish God **JAH**, one of the forms of the **Tetragrammaton**.

Finally, **6** and **9** identify the **Triangle** of the **1st “Holy Trinity”** of Freemasonry!

¹ J. Chevalier, A. Gheerbrandt, **“Dictionary of Symbols”**, Bur Ed. Rizzoli, 1997, vol. II, p. 377.

The straight lines AC and BD connect in O, vertex of the isosceles triangle, at the height of **6** meters.

The insults to God One and Trine, on the Tabernacle

- The **blasphemous Masonic Triple Trinity** in place of the **Holiest Trinity**;
- the "**5-pointed Star**" on the Chapel of Worship = **666**;
- the distance of the central axis of the stele from the base = **18 = 666**;
- the Width of the stele = **9 = 666**;
- the Depth of the stele = **9 = 666**;
- the "**5-pointed Star**" on the Tabernacle = **666**;
- the "**6-pointed Star**" on the Tabernacle = **18 = 666**;
- on the 2 fish of the Tabernacle = **33, 5, 6, 18, 9, 6, 11**;
- **6** tiles on the left + **6** degrees of the 13th tile + **6** tiles on the right = **666**;
- the dimensions of the niche: $30 \times 32 \times 70 = 3, 5, 7 =$ "**Master**" **Mason**;
- the numbers imprinted on the 2 fish of the Tabernacle = **33, 5, 6, 18, 9, 6, 11**;
- the Height of the pyramid of the stele = **6** (n. of the impious);
- the **13th** tile of the Pelican = **13** (diabolical number);
- the Height of the niche of the Tabernacle: **13** (diabolical number);
- the Height of the stele = **3.5** (number of the evil powers).

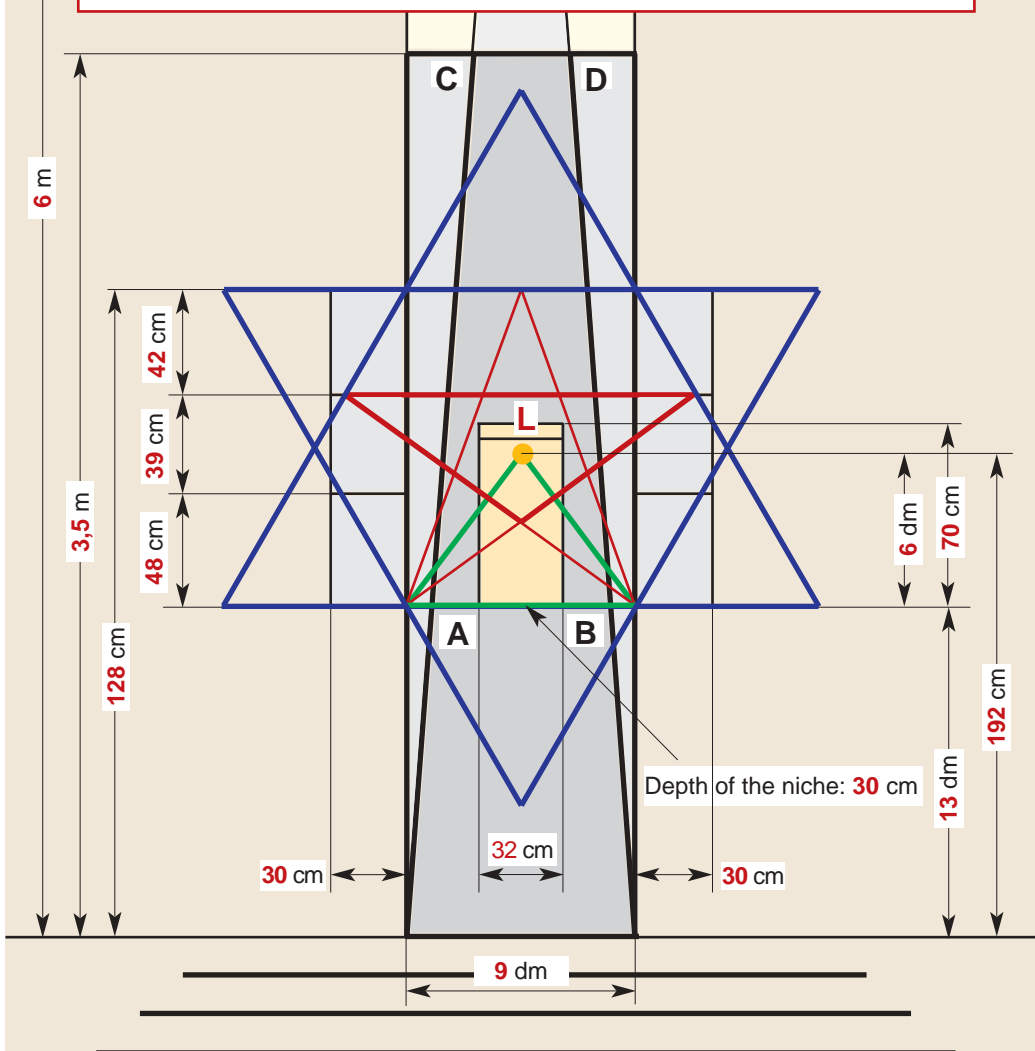

The dimensions $30 \times 32 \times 70$ of the niche inside the Tabernacle represent the numbers **3, 5, 7** of the "**Master**" Mason become "**perfect stone**" or, better, "**divinized man**". Would that be the substitution of the "**Master**" **Jesus** with the "**divinized Man**" or, better, with the "**Satanized Man**" of Freemasonry?

Creating a triangle with the base of the stele = **9 dm** with a point at a height of **6 dm** (taking the meaningful number **6** of the height of the vertex of the pyramid of the stele), one obtains the **Triangle ABL**, which is the **Triangle** of the **1st Masonic "Holy Trinity"**. The "**black stone**" stele, therefore, with its dimensions **9** and **6**, represents the "**Matter**" in the condition of "**primordial chaos**".

Facing the **open Tabernacle**, with the **3 tiles** on the right and **3 on the left**, one has, immediately, the vision of a geometry made up of **4 horizontal parallel lines** and **4 vertical ones**, defined by the edges of the stele and by the outer and separation lines of the **6 tiles**.

Traced the vertical axis of the stele, with the experiences already made, it all comes automatically: one traces the "**5-pointed Star**", from the 2 lower central points, then the "**6-pointed Star**" whose horizontal axis intersects with the vertical one of the stele, identifying the "**central point**", which is the **center** of the "**up-turned Triangle**" of the "**5-pointed Star**". As we have previously seen, in the structure of the "new church", the whole of the "**5-pointed Star**", of the "**6-pointed Star**" and of the "**central Point**", form the **2nd Masonic "Holy Trinity"**, the "**divinized Man**", whereas the "**up-turned Triangle**" with the "**central Point**" form the Masonic "**Holiest and Indivisible Trinity**", the **3rd "Holy Trinity"**, namely, **Lucifer** together with the **Patriarch of the World** and the **Emperor of the World**.

And where, instead, is the **1st Masonic "Holy Trinity"** hiding? This is represented by the **Triangle**, traced in a white line in the photograph in the next page, and, physically, is constituted by the "**black Stone Stele**" representing the **Matter** (Fire, Earth, Water) "**at the primordial state of chaos**".

Now, "this Matter with the two sexes forms the Body that, with the Soul, generated by the Fire with the Air" forms that which the UN secretary calls "**The earth on which we live**", which needs the "**Holy Spirit**", "**generated by the Fire with the Light**", in order to give "life".

In other words: since the "**perfection**" of the "**Master**", or of the "**perfect stone**", is always intended **not in "material", but in "spiritual" terms**, the speech of the former UN Secretary, **Dag Hammarskjöld**, means: the profane world (we poor Christians), who form the "**Body of the World**", first need a **Soul**, and then the "**Light**" of **Freemasonry**, which, with the "**Fire**" of the rebellion against God, produces the "**Holy Spirit**" of **Lucifer**, who gives us "**Life**", that is, causes us to become "**Masters**", "**Men-god**", "**perfect stones**"! These are the "**stones**" Freemasonry uses to edify its **Temple**!

What does all this mean to a **poor Catholic faithful** who enters this "**new church**"? According to the High Initiates, it means that **he must climb the 15 Masonic steps, in order to acquire the "Holy Spirit"**, to "**divinize himself**" and become a "**Master**", or, better, a "**perfectly Satanized man**"!

And what does this mean, instead, to the **Catholic Clergy** administering the sacraments?

For them, the **High Initiates** have another program, which is the real content of the **13 tiles of the Tabernacle**!

On the Tabernacle the satanic Triple Trinity!

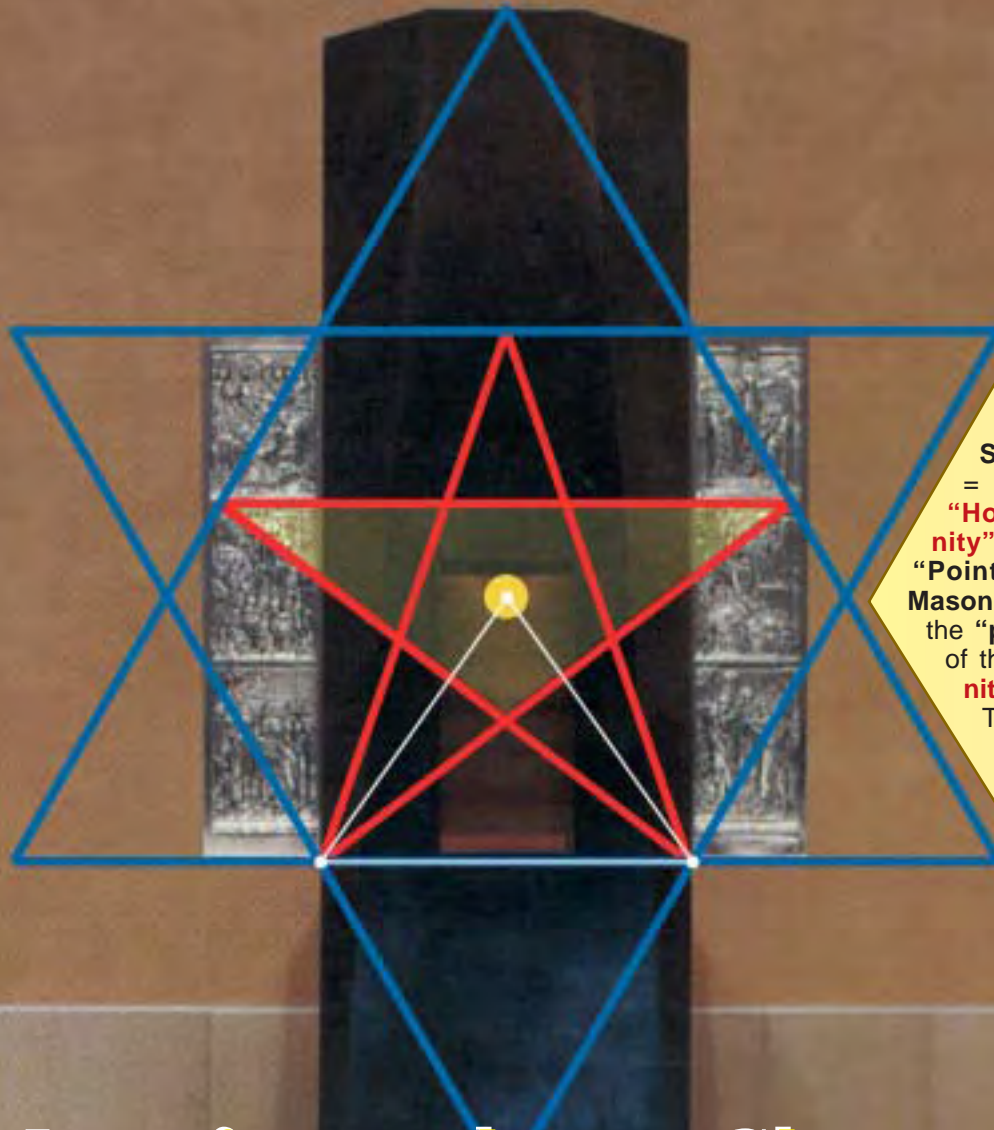

The universal axis:
in this geometry, the axis is that of the “5-pointed Star”, of the “6-pointed Star”, of the “central Point” = **Lucifer** of the Masonic “**Holiest and Indivisible Trinity**”, which coincides with the “Point” of the “**Fire**” of the **1st Masonic “Holy Trinity”** and with the “point” of the “**Holy Spirit**” of the **2nd Masonic “Holy Trinity”**:

The truth that Lucifer communicates to man is the **Unity of the Triple Trinity**, and the **Divinization of the Matter, of Man and of Lucifer**.

Lucifer replaces Christ as man's Redeemer

The geometrical shapes, composed of the width and height of the **black stone** stele of the Tabernacle, with those of 6 tiles at its sides, provide the lines and the points to trace a “**5-pointed Star**” inscribed into a “**6-pointed Star**” with a **central Point**. The **Triangle**, highlighted in white, represents the **1st Masonic “Holy**

Trinity”; the **two 5 and 6-pointed Stars**, with the **central Point** represent the **2nd Masonic “Holy Trinity”**; the central **upturned Triangle** with the **central Point**, represents the Masonic “**Holiest and Indivisible Trinity**”, or, better, the **3rd Masonic “Holy Trinity”**.

The 13 Silver Tiles:

- Transformation of the "Catholic Clergy" into "Political Class"? -

The 13 tiles of chiseled silver, work of the sculptor Floriano Bodini, with respect to the niche of the Tabernacle, are located: 6 on the left hand side (3 of the Old Testament and 3 of the New Testament); 6 on the right hand side (3 of the O.T. and 3 of the N.T.); the 13th covers the niche of the closed Tabernacle.

The meaning of the symbolic contents of the 13 tiles is the program which the High Initiates wish to actuate with the Catholic Clergy: its transformation, from "Priests of Christ", into "political Class" at the service of the World Government of the Antichrist".

The Supernatural must disappear, "Western Churches must be secularized" and the "Universal Religion", which must embrace all the religions of the globe, must constitute the "very essence, the double, triple, fourth, fifth essence, at it were, of the policy" of the World Government.

The themes developed by the 13 tiles are drawn from the rituals of the first 5 degrees of the 3rd series of 11 degrees of the A.A.S.R.: 23rd, 24th, 25th, 26th, 27th, developed in 6 + 6 tiles of the O.T. and N.T., with the 13th tile of the "Pelican" covering the last 6 degrees.

The 3rd series of 11 degrees of the A.A.S.R. has, in fact, the scope of transforming the Masonic "Priest" of the 22nd

degree (who has already fought Catholic Virtue and Morals, with the "Cult of the Phallus" and with the "Cult of Man") into a "Political Man" at the service of Lucifer, in order to fight Catholic Authority, with the "Cult of Lucifer".

The deepest "Mystery" of these degrees is the declaration of war on the "Religion of Christ", as affirm the Hidden Chiefs, in one of their secret instructions: «it is Religion that must be the constant thought of your assaults, for a people has never survived his Religion, and because, by killing Religion, we shall have in our hands Law and Property; because by establishing, over the cadavers of these assassins (the Priests faithful to Christ - author's note), the Masonic Religion, the Masonic Law, the Masonic Property, we shall have regenerated Society».

This, however, must be done with cunning, as "Religion must be eradicated with shrewdness"!

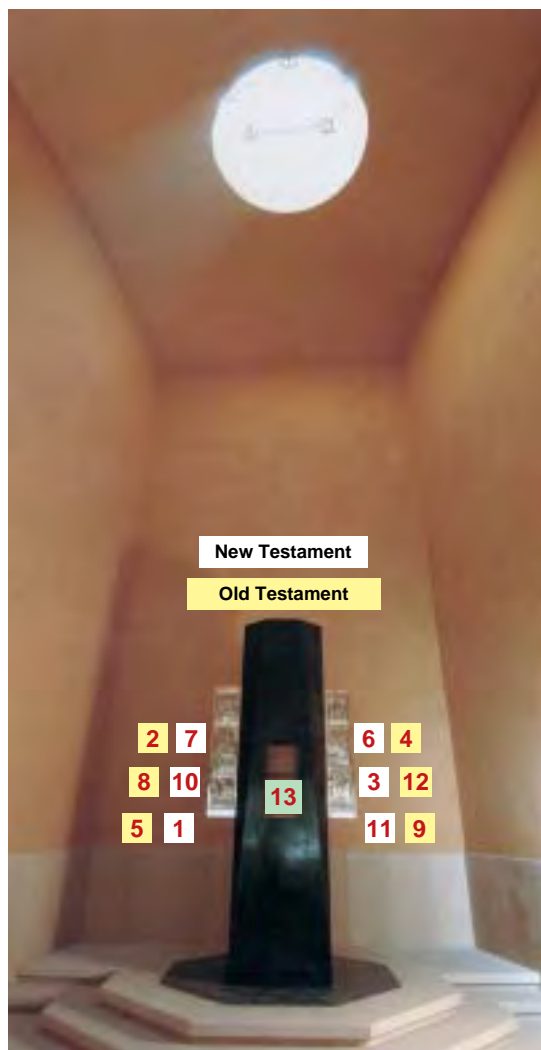

Disposition of the 13 Silver Tiles on the Tabernacle.



1

2



3



4



5

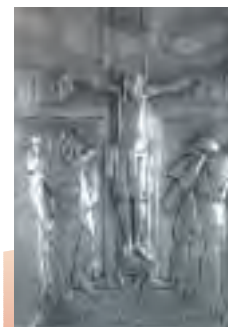

6



7

Abel offers the Lamb: the Mason

Abraham offers his own son to God: the Mason Candidate performs the "act of submission".

Resurrection: the Mason Candidate performs the "act of faith".

Melchisedech offers God bread and wine: the Mason Candidate recruits a soldier for the armada of the Temple, namely, the armada of Lucifer!

Introduction of Jesus to the Temple: the Mason Candidate is introduced to the Temple of the third series of 11 degrees. The Candidates burns incense to Lucifer and vows to recruit soldiers for the armada of the Masonic Temple.

13



33rd degree 32nd degree 31st degree 30th degree 29th degree 28th degree

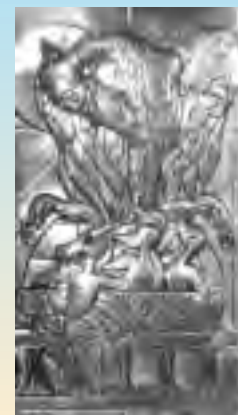

Pelican: the Mason sees the degrees that are still missing for his complete incorporation into the “mystic body” of Satan.

12

27th degree



The Jewish Easter: the Mason joins the “Court of Lucifer”.



11

Emmaus: the Mason learns the password: “Gomel” (peoples of Lucifer), the only two peoples with which he can communicate, outside the Lodge.



Multiplication of the loaves: to the Mason is revealed the 3rd Scottish Trinitary Mystery: the “heaven of Reason”: the material Needs of humanity.

10



Elias is fed with bread in the desert: to the Mason Candidate is revealed the 2nd Scottish Trinitary Mystery: the “heaven of Conscience”: the social Needs of humanity.

9



The rain of the manna in the desert: to the Mason is revealed the 1st Scottish Trinitary Mystery: the “heaven of Intelligence”: the political Needs of humanity.

8



Last supper: the Mason becomes a Spirit and, with two wings, flies out in the three heavens of Intelligence, Conscience and Reason.

26th degree

The Mason, after flying out in the there “heavens” of Intelligence, Conscience and Reason, knows the 3 “Trinitary Mysteries”.



25th degree

Crucifixion: the Candidate is initiated to the “cult of the Serpent”, namely, Satan replacing Jesus Christ on the Cross.

The Mason performs the act of cult to the Serpent-Satan who replaces Christ on the Cross.



Candidate performs the “act of worship” to Lucifer.

24th degree

The Mason performs the “act of faith”, the “act of submission” and the “act of worship” to Lucifer.



23rd degree

The Mason is received in the Temple, burns scented incense to Lucifer and vows to recruit soldiers for the Armada of the Temple.





Introduction of Jesus to the Temple

(The Mason is received in the Temple
and burns scented incense to Lucifer)



References to the ritual

- The **Candidate**, in the place of **Jesus**, plays the part of the **Son of Hiram (Lucifer)**;
- the floor, made of **white and black tiles** (indicating the **Masonic Lodge**), totals **23 tiles** (11.5×2) = **23rd degree**.
- the panels of the vault of the Temple are **3 times 6 = 666**;
- in the middle of the Temple, stands **the 7-arm chandelier**;
- on the right hand side of the dove, the n. **49** of the lights of the Lodge is observed;
- the **President (1)**, the 3 **Priests (2, 3)** and the 3 **Assistants (4, 5, 6)** welcome him;
- the **Sacred Motto** is **Uriel** (God-Fire), it is written on the left hand and on the stole of the President, in the Masonic alphabet;
- the Candidate enters the **3rd sphere of the 11 degrees**: the sphere next to Jesus shows **3 zigzag segments** and the n. **11**, with other **2 n. 11** close by (green and blue);
- to the left of Jesus, it is symbolized the "**jewel**": **the incensory** that makes the incense soar toward the **Dove-Lucifer**;
- the **Good Beginning, Angel of Light, Great Architect of the Universe**" is symbolized by the **Dove** showing the numbers **18 = 666** (red lines); **3 times 6 = 666** (light blue lines); and the n. **13** (green lines).

The Ritual

23rd degree of Ancient and Accepted Scottish Rite

The Chief of the Tabernacle

«The President of this degree is the "**Sovereign Grand Sacrificer**" of "**Solomon**" who, accompanied by **2 Priests** and **3 Assistants**, receives the Mason candidate to give him his **political education**.

The Candidate still belongs to the "**nave**" of the Masonic Temple (namely, the "**5-pointed Star**"), and only in the following degree will he enter the "**Sanctuary**" (the "**6-pointed Star**"), which is called "**Hierarchy**".

As a fresh "**political man**", the **Candidate** plays the part of the **son of Hiram** (the "**Master**" of the **Temple of Solomon** symbolizing **Lucifer**, slain by the **Three Persons of the Holy Trinity**), and learns that the three assassins, the **priests, the kings and the landlords**, designated with the epithets of **hypocrites, traitors and depraved**, are maneuvered and directed by **Adonai**, the God of the Christians.

The passage from the "**priestly**" to the "**political**" condition is illustrated with these words: "**Superstition** (that is, Religion) **must be eradicated with shrewdness and, consequently, it is incumbent upon the leading classes to declare war on Superstition** (that is, to Religion)".

The **Password** is "**Uriel**" (= God-Fire) who admits the Candidate into the **sphere of the 3d series of 11 degrees** of the Masonic degrees, into the **Tabernacle of the revealed truths**, not however (revealed) by Adonai, the God of the Ancient Jews and of the Christians, but by **Lucifer**, whom here is called "**Good Beginning, Angel of Light, Great Architect of the Universe**" to whom the Priests **offer incense** and, in his honor, carry, as **Jewel**, an "**Incensory**".

The Lodge has 2 apartments: the first is called the **Vestibule**; the second is the **Lodge**, which must be perfectly round. Its décor is changed **3 times** on the occasion of the reception. In the middle, stands a burning **7-arm chandelier**. In all, there are **49 lights**. The Lodge is called "**Hierarchy**".

(Meurin, cited work, pp. 344-345).





Melchisedech offers God bread and wine

(The Mason vows to recruit soldiers for the Armada of the Temple)



References to the ritual

- **Melchisedec, King and Pontiff** of Salem (Jerusalem), symbolizes the **President** of the Lodge;
- **Abraham**, represents the **Candidate** who has recruited a person;
- above: **9** points = **666 + 13** signs coming out of the **9** points, the **triangle** with a **4th** inner section, Melchisedec's mitre with the **3** circles and **4** segments, identify **Lucifer** and the **sacred Delta (3)** with the **4** letter of the **ineffable Name**;
- the theme symbolized is the **war on the Holiest Trinity**, symbolized by the **Cross**, which is always represented with a further sign that disfigures it;
- the recurring **n. 5**, obtained with rectilinear or curved sections, indicates the "**5-pointed Star**" and, therefore, **Freemasonry** and its **armada of the Temple**;
- the whole of the **n. 5** and of the **n. 6**, obtained also by adding one unit to the previous **5**, indicates the **mystic number 11** of the Hebrew Kabbalah, and again **Freemasonry** in the whole of the "**5-pointed Star**" and of the "**6-pointed Star**".

The Ritual

23rd degree of A. A. Scottish Rite

The Chief of the Tabernacle

«The welcoming session of the Masonic Candidate, chaired by the "**Sovereign Grand Sacrificer**", ends with a ceremony in honor of the "**Good Beginning**", **Great Architect of the Universe**".

The Candidate learns that **Hiram** (symbolizing **Lucifer**) has been slain by the **three assassins** (symbolizing the **Three Persons of the Holiest Trinity**): the **priests**, the **kings**, and the **landlords**, designated with the epithets of **hypocrites**, **traitors** and **depraved**, who are maneuvered and directed by **Adonai**, the **God of the Christians**.

Since Lucifer fights Adonai, the God of the Christians, since time immemorial, as a **fresh "political man"** engaged in this war, **the Candidate must commit himself to "recruiting soldiers for the armada of Lucifer, the Savior of men"**. The Mason Candidate, therefore, vows to recruit other masons.

It must be noted that the "**Sovereign Grand Sacrificer**" is a Mason of the 33^d degree, therefore, according to the Kabbalistic doctrine of the 33 degrees of the Ancient and Accepted Scottish Rite, other than being his own **God**, he is also his own **Pontiff** and **King**».

(Meurin, cited work, pp. 344-345).





Resurrection

(The Mason performs the “act of faith”)

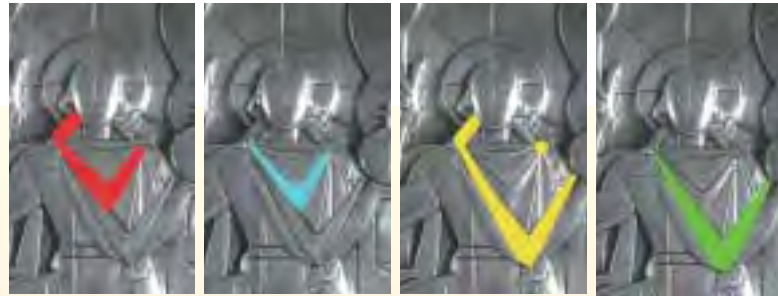

The “Mark” of **Great Architect Of The Universe**, (which in Italian is **G.A.D.U.**) is imprinted in the Masonic alphabet upon the resurrected Christ.

References to the ritual

- **Lucifer**, with the n. **6** (double triangle), with the **7-rays Sun**, and with the numbers **6, 9, 13**, with **5 spirals, 3 times 6**, holds in his hands the **small globe** of Christ;
- the **3 times 6** (blue, green, nad brown lines), and the **2 times 9** (red zigzag line and curved lines, to the right) are the Candidate’s reply as to his work at the Temple;
- the **Act of faith**, is represented by the **3 people**, at bottom: one covers his eyes; the other two, instead, indicate, on the chest, the **3 points** of **Kabalistic Triad**;

The Ritual

24th degree of A. A. Scottish Rite

The Prince of the Tabernacle

«In this degree, the Candidate enters the **Temple** called “**Hierarchy**” of the **Spirits**. He is asked **how many days** has he worked in the **Temple of Solomon**. He replies: **2185** days, that is, **3 times 6** years or **2 times 9** years; he has still to cover the **3 triangles of the third series**. Here is the essence of this degree: “**Solomon**, for changing his cult, **has lost communication with Adonai**. He, however, has acquired an extraordinary knowledge of the **Kabbalah** and **has been able to come in touch with the Spirits of the Fire!**” Here is the “**recovered Word**”: **the word of Lucifer to man! 3 acts** are required of the Candidate: “**Act of faith**”, “**Act of submission**”, “**Act of worship**”.

Act of faith: “the right hand is brought onto the eyes, as if to avoid a strong light; keeping the left hand on the chest, the right hand is brought toward the left shoulder and, from this, diagonally, on the right flank”, to indicate the points of the **Physical Triad** (24th, 25th, and 26th degrees).

The **Jewel** is “a **small golden globe**, surmounted by a **double triangle** surrounded by rays and at the center the word **Jehovah**, evidently, **Lucifer**.”

The Christians place into the hand of Baby Jesus a **small globe surmounted by a Cross**. Here, we see **Lucifer** contend to Christ the power on earth».

(Meurin, cited work, pp. 345-348).





Abraham offers his own son to God

(The Mason performs the “act of submission”)



References to the ritual

- **Abraham** symbolizes the **Candidate** who must perform the “**Act of submission**” to Lucifer;
- the **Angel**, who lay his hand (a man that seems to represent two) is **Lucifer, Angel of Light**, on account of the numbers **5, 9, 13** marking him;
- the double **24 circles** at the base indicate that we are at the **24th** degree;
- the **6** remaining circles, divided into **3 + 3**, indicate **3** times **6** years, of the work the Candidate has already carried out at the **Temple of Solomon**;
- the **3 triangles** placed on the altar, indicate the **3 Kabalistic Triads** the Candidate must still cover in this **3d series** of **11 degrees**;
- the **3 triangles** placed on the body of Abraham (the Candidate) indicate the submission to Lucifer of the **3d Triad**, the **Kabalistic intellectual Triad**.

The Ritual

24th degree of A. A. Scottish Rite

The Prince of the Tabernacle

«In this degree the Candidate enters the **Temple** called “**Hierarchy**” of the **Spirits** and has before him the **3 triangles** representing the **Physical, Moral** and **Intellectual Triad** of this **3d series** of **11 degrees** of the Freemasonry of the A.A.S.R.

Here is the essence of this degree: “**Solomon**, for changing his cult, **has lost communication with Adonai**. He, however, has acquired an extraordinary knowledge of the Kabbalah and **has been able to come in touch with the Spirits of the Fire!**”

Here is the “**recovered Word**”: **the word of Lucifer to man!**

3 acts are required of the Candidate:

- “**Act of faith**” (already seen);
- “**Act of submission**”;
- “**Act of worship**” (theme addressed in the next tile).

Act of submission: “the two open hands are brought on the head, joining the two index fingers so as to form a **triangle**”. The Candidate, in this manner, expresses the submission of his intelligence (the **triangle** of the **Kabalistic intellectual Triad**) to the **God-Fire (Lucifer or Angel of Light)**».

(Meurin, **cited work**, pp. 345-346).





Abel offers the Lamb

(The Mason performs the “act of Worship” to Lucifer)



References to the ritual

- Abel represents the **Candidate** of the **24th degree** whom is required the **Act of Worship** to the **God-Fire, Lucifer**.
- the **24 small circles**, at the foot of Abel to the right, indicate the **24th degree**;
- the days worked at the Temple are: **3 times 6** (yellow), and **2 times 9** (green);
- the Candidate **“bows his head forward”**, while the person at bottom **“covers his eyes with his left hand”**;
- the **“Seal of Solomon”** (two intertwined triangles of the “**great World**” and of the “**small World**”, one with the tip facing downward; the other facing upward, is represented by the divine Man **Adam Kadmon** (the whole of the **10 Sephirot** of the Kabbalah: **1 + 3 + 3 + 3 + 1 = the World** and the **3 triangles**) united by the **Ensoph: the Elder of Elders** (in the triangle) of the Kabbalah; and by the **Candidate, the super-human being** who, by ascending in degree: **1 + 3 + 3 + 3**, completes the **10 Sephirot**, united by the letter **“G”** expressing Creation, intended as **“Generation”**).

The Ritual

24th degree of A.A.S.R.

The Prince of the Tabernacle

«In this degree, the Candidate enters the **Temple** called **“Hierarchy” of the Spirits**.

Here is the essence of this degree: **“Solomon, for changing his cult, has lost communication with Adonai. He, however, has acquired an extraordinary knowledge of the Kabbalah and has been able to come in touch with the Spirits of the Fire!”**

Here is the **“recovered Word”**: **the word of Lucifer to man!**

3 acts are required of the Candidate:

- **“Act of faith”** (already seen);
- **“Act of submission”** (already seen);
- **“Act of worship”**.

– **Act of worship**: **“The head is bowed forward and, with the left hand, the eyes are covered. Cordial Act of Worship of the dazzling God-Fire”**.

In this degree, the system of the two origins of the deity, represented by the **“Seal of Solomon”**, is explained: the double triangle intertwined with the two Elders, representing the **white Jehovah** and the **black Jehovah**. The representation of the two elders, however, is not exact: the **Kabbalah** calls **“Elder”** the **Great face**, but there are not **two Elders**, but only one: **the Ensoph: The “Elder of Elders”**».

(Meurin, **cited work**, pp. 345-346).





Crucifixion

(The Mason performs the “act of cult to the **Serpent-Satan**” who replaces Christ on the Cross.



The egyptian “Ankh”

«The shape of the **Ankh** is that of a cross, and we do know that the latter was the ancient **symbol of eternity**. It is the symbol of **eternal life**. But the gulf in the upper part seems to be the sign of a string **knot** that means: **to tie, to untie...** Hand-held by the deities (or pictured beside them), it is the **symbol of sacred occultism**. Hence, the **knot** represented, above all, the **occultism protector of the mysteries of Religion**».



Fig. 86. - L'Ankh inscritto nel Pentagramma.

The Ankh inscribed into the Pentagram.

The Ritual

25th degree of Ancient and Accepted Scottish Rite

The Knight of the Brazen Serpent

«In the 25th degree are found the **Ophites**: the **worshipper of the Serpent**. The essence of this degree is the “**Cult of the God-Serpent**”, classic symbol of **Satan**.

Above the altar of the room stands a transparent representing the **JA, JE, JI**, the **Masonic Jehovah**, in the middle or a burning briar.

The Lord appeared to Moses in a burning briar that would not be consumed... hence, **Lucifer would not be consumed** in the eternal Fire of which he is the immortal inhabitant, either.

A **truncated-cone** shaped **small heap**, in the middle of the room, carries a **bronze serpent** crouched down on a trestle.

The Lord said unto Moses: “Make thee a **bronze serpent** and set it (upon a pole) as a sign; everyone that is bitten, when he looketh upon it, shall live”.

Our Lord, for that reason, said: “Just as Moses lifted the **Serpent** in the desert, so must the **Son of Man** be lifted up (on the **Cross**) so that **he that believes in him shall have eternal life**”.

The focal point of this degree is **the comparison between the Christ and Satan**, both represented by the **bronze Serpent**.

The **Christ on the Cross** becomes the **Death of Death** “in order to destroy with death he that had the empire of death, namely, **the Devil**”.

Satan, on his part, making that image his own, says to the Candidate that it is he who healed the Jews in the desert; he, the Angel of Light of whom the **Serpent** is one of the emblems. Hence in this manner, placed on the Cross, the **Serpent** represents **Satan**, who presents himself, by **replacing Christ**, as **the true Savior of humanity, the true “Master”**.

The mystery of this degree is a profound one.

As the **Christian Baptism**, and the other Sacraments, are a mystical transformation of the natural man into **Son of God**, dying to the previous life of sin in order to be **incorporated into God**, so the **Devil** actuates, with the progressive work of Freemasonry, **the incorporation of man into his diabolical personality**. Man must die, like **Hiram**, **in order to resurrect as a new Lucifer!**

The **sacred Motto** of this degree is “**Moses**”».

(Meurin, cited work, pp. 348-351).



Satan presents himself to the Mason **Candidate**, replacing **Jesus Christ on the Cross** and presenting himself as he that gives the **eternal life**.

The “**5-pointed Star**” on the forehead of **Christ crucified**, means that it is not **Jesus Christ** on the Cross, but **Satan-Lucifer**.



Left: Satan **presents** himself as the true **"Master"** who gives **"divine life to man"**. The depiction of the **"Master"** is the whole of the **"5-pointed Star"** inscribed into the **"6-pointed Star"** and with the **central Point**.

Right: the **9** zigzag steps to imitate the movement of the serpent (**4** red zigzag lines and **5** other to the side); and the **9** knocks of the battery, divided into **5, 3, 1** (5 red lines, 3 yellow, 1 green on the chest and the white, red, and blue rays around the head). The Sacred Motto **"Moses"** is written in the Masonic alphabet (**2** yellow lines, **1** red and **1** green on the belly). The two people (male and female) represent the **2 sexes** of the **"Deity"** represented on the cross.

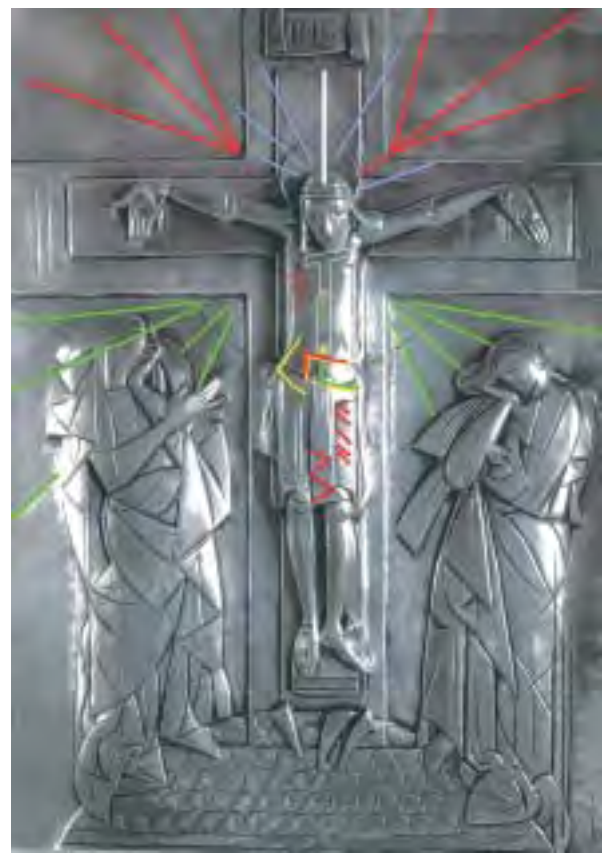

Side: depiction of the **Baphomet**, the god worshipped by the Templars and by the High degrees of Freemasonry.

- on the forehead stands out the **"5-pointed Star"**;
- on the arms, the captions **Solve, Coagula**;
- on the belly, the **Caduceus**, symbol of the **2 sexes** of the Deity;
- above and below, the white and black **Moon**;
- on the head, the **Flare** of the **God-Fire**;
- etc...

Left: **Jesus Crucified** replaced by **Satan-Baphomet** on the Cross:

- on the head is inscribed a **"5-pointed Star"**;
- on the hands stand out the letters **"S"** and **"C"** of **Solve** and **Coagula**, which appear written on the arms of the **Baphomet**;
- on the arms, highlighted in green, appears the caption **"Baphomet"** in the Masonic alphabet (the cross on the left arm, at the height of the elbow, indicates the 4 letters **B, a, p, t**, gathered together) whereas the others: **h, o, m, e**, are indicated singularly;
- the **Moon** is represented by the partial circle around the head;
- the flare on the head of the Baphomet is symbolized by the **Sun with the rays** coming out of the larger circle with center in the nose;
- the **Caduceus** is represented by the **two people** (male and female) at the foot of the Cross, whom receive the rays of the **Deity**, indicating its **2 sexes**;
- the caption **"INRI"**, to the High Initiates, means: **"Igne Natura Renovatur Integra"** (la Natura Intera è Rinnovata col Fuoco - *the Whole Nature is Renewed with Fire*): the **Fire** of the **God-Fire, Satan**.



Last supper

(The Mason, a new spirit, flies into the three “heavens” of Intelligence, Conscience and Reason)



References to the ritual

- The floor of **white and black tiles** indicates the **Masonic Lodge**;
- the **Candidate** is welcomed by the Court of Lucifer composed of **9** Courtisans;
- the **9 zigzag steps** of the Serpent are the tiles of the same color (black);
- the **9 steps** the Candidate must climb, are the tiles of the other color;
- **two wings** are attached to the Candidate which allow him to fly out in the **3 heavens (1st, 2nd, and 3rd)**;
- the **particle**, which **Lucifer** gives the Candidate, symbolizes **his incorporation into the army of the demoniac Spirits**;
- the **diabolic Spirit** of the Candidate is symbolized by the **n. 6** marking him;
- the **Sign of recognition** is the **Triangle** the Candidate forms “with the first fingers of the two hands and placed on the belly”, “suggested” by the (green) arrow;
- in the **3rd heaven**, the Spirit of the Candidate finds itself in the presence of the **Prince of darkness**, of the **God-Fire** whom he must see **as is: Lucifer**, the “**Sun with the 7 rays**”; **Lucifer, center** of the blasphemous **Masonic “Triple Trinity”!**

The Ritual

26th degree of A. A. Scottish Rite

The Prince of Mercy

«**The incorporation into the army of the demoniac Spirits** produces, as it were, a **New Spirit** that, by its own nature, must be able to enter the regions in which its brothers dwell.

First the Candidate takes **9 steps** snaking, **Sign** of the previous degree, and symbolizing the march of the **God-Serpent** that never walks straight.

They attach **two wings** to his shoulders, **symbol of the spirits**. Everywhere, even in the Church, winged Angels are always represented, to indicate their spirituality.

The Candidate, therefore, **represents a Spirit**.

Incorporated into the chorus of the Demon, in the previous degree, he must climb **9 steps**, perhaps in honor of the **9 Sephirot** submitted to the **Great Architect of the Universe**.

From the platform on which he is standing, blindfolded, he must fly out from the **first heaven**, to the **second heaven**, and then on to **the third heaven**, in the presence of the **Prince of darkness**, of the **God-Fire** whom he must see “**as is**”.

The **Sign of recognition** consists in a **triangle made with the first two fingers of the two hands and placed on the belly**: the Kabalistic **physical triangle** is completed».

(Meurin, **cited work**, pp. 352-353).

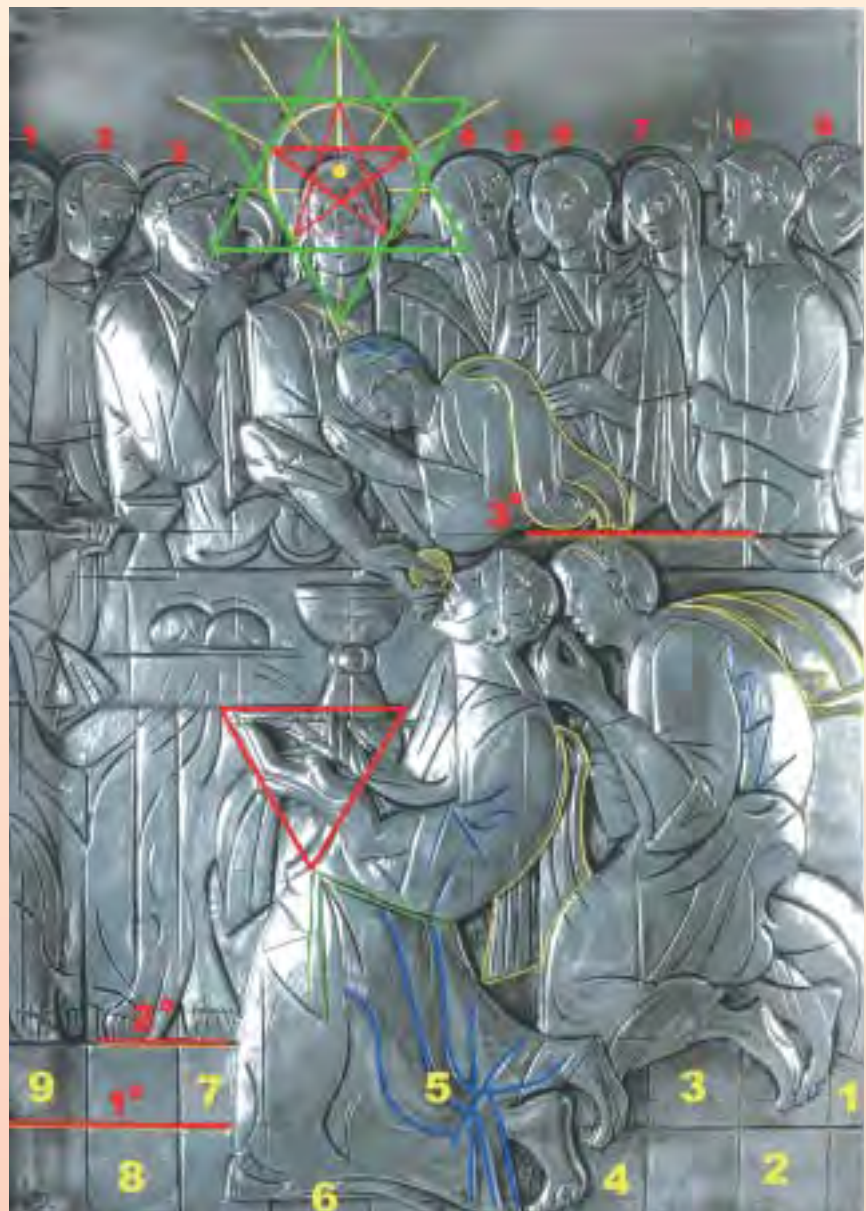



The rain of the manna in the desert

(The Mason knows the
1st Scottish Trinitary Mystery)



References to the ritual

- **Moses** represents the **Candidate** who, marked by the n. **13** and **7**, by the **3 triangles** yet to be covered in Freemasonry, by the word “**Moses**” written with the fingers of his left hand, in the Masonic alphabet, now knows the **1st Trinitary Mystery**: the **political Needs of Humanity = destruction of the 3 Enemies**;
- this task is entrusted to the **7** people to the left and to the **8** to the right, who add up to **15 = 5-pointed Star = Freemasonry**;
- the person with the **15** small green circles on his head, carries written on his back: **2 times 9**; **3 times 6**, which are the knocks of the Battery of this degree;
- the **12** small circles and the **9** (2 incomplete + 7) indicate the **Table of the 12 Commandments**, not Moses’s, but of the **Round Table** of the **Templars** of the **27th** degree;
- the **Great Hand** indicating **3** (the **3 enemies to fight** of which **Religion**, represented by the **3 tiaras**, is the main one) is marked by the n. **3** (yellow), **13** (blue), **15** (red), **18** (green), **3 times 6** (green), **2 times 18** (red, yellow), **6 x 6** (the squares on the background), **is the hand of Lucifer**, whereas the numbers **15 + 18 = 33**, indicate Freemasonry. To the left, in the foreground, appears the n. **6**, the impious.

The Ritual

26th degree of A. A. Scottish Rite

The Prince of Mercy

«**The Candidate**, to whom they attached two wings to the shoulders, symbol of the spirits, **represents a New Demonic Spirit**.

From the platform on which he is standing, blindfolded, he must fly on to the third heaven, passing first through the first and through the second.

He hurls himself and falls onto a cover held by some vigorous Friends. He is in the **first heaven**, that of the **wandering stars** – the stars representing the Spirits; he is in the “**air where are scattered the Spirits of malice**”.

The **novel Spirit** of the Candidate is introduced to the

1st Scottish Trinitary Mystery.

He has soared in the **region of the Intellect** that corresponds to the **political needs of Humanity**.

In this degree, one promises to work on the **12 Commandments** of the **Table of the Law**. Certainly, that Table **is not Moses’**, but the **Round Table** of the **Templars** in the **27th degree**».

(Meurin, cited work, pp. 352-353).





Elia is fed with bread in the desert

(The Mason knows the
2nd Scottish Trinitary Mystery)



References to the ritual

- **Elias** symbolizes the **Candidate** who understands the meaning of the **social Needs of Humanity**: the **Materialization** through the liberation of mankind from the **Priests** and from all **Religions**;
- the **Angel** that feeds Elias is a **Spirit of the Christian God**, a **Priest**; in fact his wings are studded with the numbers **3** and **10** (**3** for the Holiest Trinity with the **7** Attributes of God that, added up to **3**, give **10**); moreover, he (the Angel) has the **halo** and the **crown of thorns** of **Christ**. **His throat has been cut**, while behind his head are observed the capital letters **CDL = 450** (in Roman numerals), indicating the **450 Priests slaughtered by Elias** at Haifa. Blue-hatched, on the left shoulder, **two arms lifting the number 450**, as if **offering it in holocaust to the Deity-Lucifer**, are observed, represented (the n. 450) by the **13** red undulated sections, as if they were swells of smoke flowing out of the **flames**, to the left, at the bottom of which there appears a **Phoenix**, symbol of **Lucifer**.

The Ritual

26th degree of A. A. Scottish Rite

The Prince of Mercy

«**The Candidate**, to whom they attached two wings to the shoulders, symbol of the spirits, **represents a New Demonic Spirit**.

From the first heaven, the Candidate must move on to the next.

They make him move on to the **second heaven**, the ethereal heaven, symbolized with the soap-foam he must absorb. There, are the **fixed stars: the demons chained in hell**.

He brings a burning candle to his fingers, to represent the heat of the **fixed stars of hell** wherein he has arrived. To console him of the ominous thought of the future eternal fire, he is assured that, from now on, his body has acquired the property of resisting the fire! The **novel Spirit** of the Candidate is introduced to the

2nd Scottish Trinitary Mystery.

He has soared in **the region of the Conscience** that corresponds to the **social needs of Humanity**».

(Meurin, **cited work**, pp. 352-353).





Multiplication of the loaves

(The Mason knows the
3rd Scottish Trinitary Mystery)



References to the ritual

- The **Candidate** indicates, with the **3** raised fingers, the **3rd Trinitary Mystery**: the **material Needs of Humanity**: the **Imposition** upon the **individual**, upon the **family** and upon the **State** of all that is Masonic, taking advantage of the material needs;
- The **Dove** carries the numbers **13** of **Lucifer** and **15** of **Freemasonry**, which seem to have eclipsed the **Cross**; also the n. **10** of the curved lines on the background seems to fade out into the horizon;
- the Candidate, who bears the signs of the n. **3** of the **3 triangles**, and who indicates with the fingers **3 times 5 = 15** of the "**5-pointed Star**" of **Freemasonry**, is before this Mystery that contemplates the materialized humanity (**5** sheep, **11** people with children (= families), **7** dignitaries including the **Priest** wearing the tiara) that, with no more true Religion nor references (do observe their expressionless and lifeless faces) find themselves under the direction of Freemasonry and of its **God: Lucifer**.

The Ritual

26th degree of A.A. Scottish Rite

The Prince of Mercy

«**The Candidate**, to whom they attached two wings to the shoulders, symbol of the spirits, **represents a New demonic Spirit**.

From the second heaven the Candidate, having been fluttered in the air, enters the **third heaven**, in the presence of the **Prince of Darkness, of the God-Fire**, whom he must see "**as is**", "**face-to-face**", as the Christian will see good God.

He is shown the **Truth** that springs from the well. That **Truth** is represented by a "**Mason Sister in a traditional costume**", as is!

She is the Goddess of Reason.

At this point, the Candidate is left alone with the "**Truth**" after giving him an **Arrow**, vile symbol of the **god Cupid**. The **novel spirit** of the Candidate is introduced to

3rd Scottish Trinitary Mystery.

He has soared in the **region of the Reason** that corresponds to the **material needs of Humanity**».

(Meurin, **cited work**, pp. 352-353).





Emmaus

(The Mason knows the “two people” of Lucifer)



References to the ritual

- **Jesus Christ** with the two disciples of **Emmaus**, symbolizes the “**secret Master**” of this 24th degree who explains who the **Gomel** are: the **2 peoples of God-Lucifer** with which the Candidate may speak outside the Masonic Lodge;
- on the chest of the “**secret Master**” is written “**Gomel**”, in the Masonic alphabet, and on his left shoulder appears the n. **7** of the Secret Master;
- the **26** small circles to the right in the background, indicate the **26th** degree;
- the numbers **6** and **36** (6 x 6) indicate the **666**; and the numbers **3, 5, 7, 9, 18** (bottom) indicate the **Masonic people**;
- the number **22** on the head of the person to the left; the number **12** bottom right, and, particularly, the **12** rays departing from the halo of the “**secret Master**” indicate the **12 Tribes of Israel**. This people, is the **people of the Jews**.

The Ritual

26th degree of A. A. Scottish Rite

The Prince of Mercy

«The **new Spirit** of this degree, having known the **3 Scottish Trinitary Mysteries**, is informed of the “**two peoples of God**”.

The **Password**, entering the Lodge, is “**Gomel**”, namely, “**Peoples of God**”, that is, “**Peoples of Lucifer**”. To communicate outside the Lodge, there are only two peoples: the **Ghiblim** and the **Gibeon**; the two are the **Gomel**, the “**peoples of the God-Fire**”.

The **Ghiblim** were a Phoenician people with capital **Byblos**, famous for its **cult of Adonis**, who was believed wounded by a wild boar in Lebanon, whence the **Adonis** river that flows through **Byblos**, has its source. The Egyptians, every year, on the feast of **Adonis**, tossed a head-shaped box they claimed to be the **head of Osiris** in which was a letter for those of **Byblos**, into the sea. That box, they said, would reach **Byblos** unaided in **7 days**.

Gibeon stood upon a **height**, as its name, “**Height of Iniquity**”, suggests. **Solomon** traveled there, at the onset of his reign, to sacrifice. The Scripture reproached him for this: “**Solomon loved the Lord, walking in the statutes of his father David, except that he sacrificed and burned incense at the high places. He went to Gibeon to sacrifice there**”.

Gibeon was the capital of the **Gibeonites**, with whom the **Israelites** concluded an alliance, and then **enslaved** on account of their violence. **They remained always faithful to Israel**».

(Meurin, cited work, pp. 353-354).





The Jewish Easter

(The Mason joins the “Court of Lucifer”)



The cat

In this tile, appears a “sly cat” crouched down on the 4th step. What does this animal symbolize?

«The **cat** evokes the notion of **primordial chaos**, of **primal matter** non-fecundated by the **superior waters**». «In the **Kabbalah**, the **cat**, associated to the **serpent**, indicates the “**sin and abuse of the goods of this world**”. With this meaning, sometimes, **it is portrayed at Christ’s feet**».

«The cat represents the **strength** and **nimbleness** of the feline, which a guardian deity puts **at the service of man in order to help him to triumph over his hidden enemies**». «The **cat** is sometimes believed to be a **servant of Hell...** hence, he is believed to be a sacred animal, which cannot be killed if not toward religious ends and according to certain rites».

(“Dictionary of Symbols”, vol. I, pp. 485-486).

The Ritual

27th degree of Ancient and Accepted Scottish Rite

The Commander of the Temple

«The Candidate is welcomed amongst the members of the **Court of his infernal majesty**: he becomes his Courtesan. The **President** is addressed as **Omnipotent** and is wearing, as **Jesus Christ**, a blue gown and a **red cape**; at the tip of his string, there is a **triangle**. He wears a **crown of thorns** on his head.

The Candidate is brought into the room blindfolded, to make him understand that **he is still under the yoke of passions!** As an indication of that slavery, image of political slavery, he is tied up, placed upon a table, covered with a mortuary drape, and **carried in procession chanting a funeral prose**.

Next, he is untied, to show him the difference between a slave and a free man, and **he is solemnly crowned**.

Then, the Candidate vows to “**always obey the orders that will be transmitted to him in a hierarchical way**”.

The substitution of the existing governments with the power of the Order is the aim of this 3rd series of 11 degrees. Freemasonry considers itself as the secret executioner of the governments and of the peoples. **Jesus Christ, I.N.R.I.** who had assumed the title of **King of the Jews has been justly condemned; the true King of the Jews takes, here, his place**, which Jesus had usurped!

The **Sign** is this: to make a **little sign of the cross with the thumb** of the right hand.

In this degree that, with the next two, represents the soul of the devil-possessed Man, the **mother idea of the Kabbalah** is revealed through the embroidery the partakers wear on the collar of their apron.

The meaning of the collar is known: the **Teutonic Cross**, sign of the **quadruple generation** that produced the **4 worlds** – the perfection of the **triple Phallus** of the Phoenicians - appears surrounded by a golden laurel Crown. **It is the Phallus, the generating force** that opens all the treasures of nature.

Hence, one observes the **Key** embroidered under the collar, naturally on the apron, other form of the letter “**G**” (generation).

The **Battery** beats **3 times 9**, that is, **27 knocks**. They are divided into **2 times 12** and **1 time 3 knocks**.

The “**Great Supreme Trinity**”, always remaining at the apex, shines in a **triple ideal light, whose supreme generating force, represented by the mystic number 5** and of the “**5-pointed Star**”, spreads throughout the universe».

(Meurin, cited work, pp. 354-356).

The bull

In this tile also appears the figure of a “**bull**”. With what meaning?

«The **bull** evokes the idea of **might** and **irresistible zest**».

«The **bull** represents the celestial gods on account of **unflagging and uncontainable fecundity... the bull represents sexual energy**».

«In the **Temple of Solomon**, **12 bulls** support the bronze sea, destined to contain the lustral water: **3** look to the North; **3** look to the West; **3** look to the South; **3** to the East».

«The bull is always connected to the Cult of the **Great Mother: the Moon...** In Egypt, the deity of the **Moon** was the “**bull of the Stars**”.

«In Hebrew, the first letter of the alphabet, **alef**, which means **bull**, is the symbol of the **Moon**».

«Attributed to the solar deity **Mithra**, the **bull symbolizes the dead and resuscitated god...** ».

«In the Mithriac cult of **Cybel**, the bull was used for an initiation with **baptism of blood**. The bull slaughtered, its blood dripped onto the devout who wished to benefit from it, whom, through this bloody aspersion, **was reborn for eternity, born to a new life for eternity**».

«Death is inseparable from life, and the **bull presents also a funereal aspect**. With the Egyptians, the **bull**, holding a solar disc between his horns, is at one time **symbol of fecundity** and a **funerary deity**, tied to **Osiris (Lucifer)** and to his rebirths».

(“Dictionary of Symbols”, vol. II, pp. 477-483).



References to the ritual

- The **Court of Lucifer** is symbolized by the n. **6**;
- the **President** carries the **halo of Christ**, the **crown of thorns**, the **triangle** at the tip of the string of his belt, makes a **sign of the cross (Tau)** with the thumb of his right hand;
- having **condemned Christ**, the **President** takes his place **sword** in hand (Freemasonry executioner);
- **Christ condemned is the upturned lamb** with the caption **INRI** on its body (to be deciphered kabalistically), carried onto the hands of the Candidate;
- “**the mother idea of the Kabbalah**”, the “**Cult of the Phallus**”, is represented with the **Teutonic Cross** and the **Triple Phallus** of the Phoenicians, on the back and on the left shoulder of the Candidate;
- the **bull** represents the irresistible **sexual energy**;
- the **cat, servant of Hell**, indicates the **passions** to which the Candidate has been subjected, but also the **nimbleness** and the **strength** to triumph over his enemies;
- the **bull indicates the funeral** to which the candidate is subjected, and his **resurrection to a new eternal life**;
- the Candidate is “**crowned**” (plait with two cups);
- the **Battery** knocks: **3 times 9** are indicated by the **3** fingers of the courtesan n. **3** looking at the **9 studs** of the neighbor;
- the **Battery** knocks: **2 times 12 + 3**, are represented by the courtesan n. **4** indicating **2 + 3** with his fingers: the courtesan n. **2** indicates **2** toward the bull that represents the **12 bulls of the Temple of Solomon: 3** for the **4** cardinal points.

The “Great Supreme Trinity” and the “5-pointed Star”

In the tile, there exist characteristic lines and points: the vertical line from the tip of the left thumb of the “**President**”, and which falls precisely onto the **eye of the cat** (it is the **Eye of Lucifer**: sin, abuse of the goods of this world, the serpent). The horizontal line that passes through the eye, crosses the **knee of the President** and of the **Candidate**. The horizontal line, which starts from the navel of the President, meets the point of intersection of the two lines, horizontal and vertical, on the shoulders of the Candidate.

Connecting these **5 points** one obtains a “**5-pointed Star**”, perfect and supported by the left hand of the **President**, and resting on his left knee and on the left knee of the Candidate; its vertical axis and the lower horizontal line run through the **eye of the cat**.

The “**upturned Triangle**” of the blasphemous **Masonic “Holiest and Indivisible Trinity”** stands out at the center of the “**5-pointed Star**”, but the eye of the cat “suggests” to speculate upon the meaning of the circle, at the center of the Triangle: **Lucifer: it is Lucifer that draws his own Light from the Death of the Sacrifice of the Lamb**; Light which derives from the **suppression of the Sacrifice of Christ of the Cross**, returning to **Satan** the ancient power he had over men.

The **4 steps** symbolize the **4 Worlds**, namely, the Universe; hence the “**5-pointed Star**”, with its mystic n. **5**, **propagates itself throughout the Universe**”.





Pelican

(The Mason before the 6 degrees and before the Mysteries of the highest degrees that allow him his total incorporation to the “Mistic Body” of Lucifer)



28th degree



29th degree



30th degree



31st degree



32nd degree



33rd degree

The Blasphemous “Triple Trinity”

The deepest “Mystery”, revealed by the tile, is the **war on God, the erasing of the Sacrifice of Jesus Christ on the Cross** with the **replacement of Christ with Lucifer**, and the **replacement of the Holiest Trinity** with the blasphemous **Masonic “Triple Trinity”**.

This “Mystery” appears, macroscopically, in the **large Cross** at the center and in the **three circles**: one at the center and the other two at the top.

The smallest **circle**, top right, incomplete, and within a triangle, indicates the **1st Masonic “Holy Trinity”**.

The central **circle** at the bottom, with the lines intersecting it to suggest the presence of a “**6-pointed Star**”, with the presence of the **5** small ones, in the two groups of **3** and **2**, and that is, the **1st “Holy Trinity”** that, divided into the **2** sexes, forms the “**5-pointed Star**”, and with the **central point**, intersection of the axis, indicates the **2nd Masonic “Holy Trinity”**.

The top left **circle**, with the odd head of the Pelican, with the eye and the nasal hole nearly mirror, suggesting the “**upturned**” triangle, with the central point already seen, indicate the **3rd Masonic “Holy Trinity”**.

In the lower part of the tile there appears the n. **7**: the “**pointed cubic Stone**” (red rectangle) with the characteristic numbers **3, 5, and 7**.

The **6** luminous green bodies, the **6** lines of the caption, the **6** dark green identical bodies, at the bottom, form **3 times 666**, symbol of the **war on God**.

It is the central “Mystery” of Freemasonry: **the erasing of the Sacrifice of Christ on the Cross** and His replacement with **Lucifer**, who offers man his own “**Redemption**”!

The Tetragrammaton

The weapon to obtain the **Erasing of the Sacrifice of Christ on the Cross** is **Masonic Ecumenism**: symbolized by the **Tetragrammaton**, namely, **all the names of the Kaba-listic God-Lucifer**. The **Tetragrammaton** (or “**Magic Square**”) has **9** points (vertexes and intersections) in which must be placed the **9** digits, from **1** to **9**, in order to compose, in **8** directions, the number **15** of the Kabalistic god.

The “**square**” and the **9** intersections are represented by the **4** rectangles that appear at the base of the tile. The **9** digits are represented in two different manners: by **9** series of lines, above the caption “**Pie Pellicane...**”, highlighted in different colors, each identifying one of the **9** digits.

The second manner of representing the **9** digits is that of counting the “**singularities**” of the caption “**Pie Pellicane, Iesu Domine**”:

1: the comma; **2**: the accents; **3**: Pie; **4**: Iesu; **5**: the 5th letter “e” which appears 5 times; **6**: Domine; **7**: the 7 points; **8**: the 8 red lines; **9**: Pellicane.

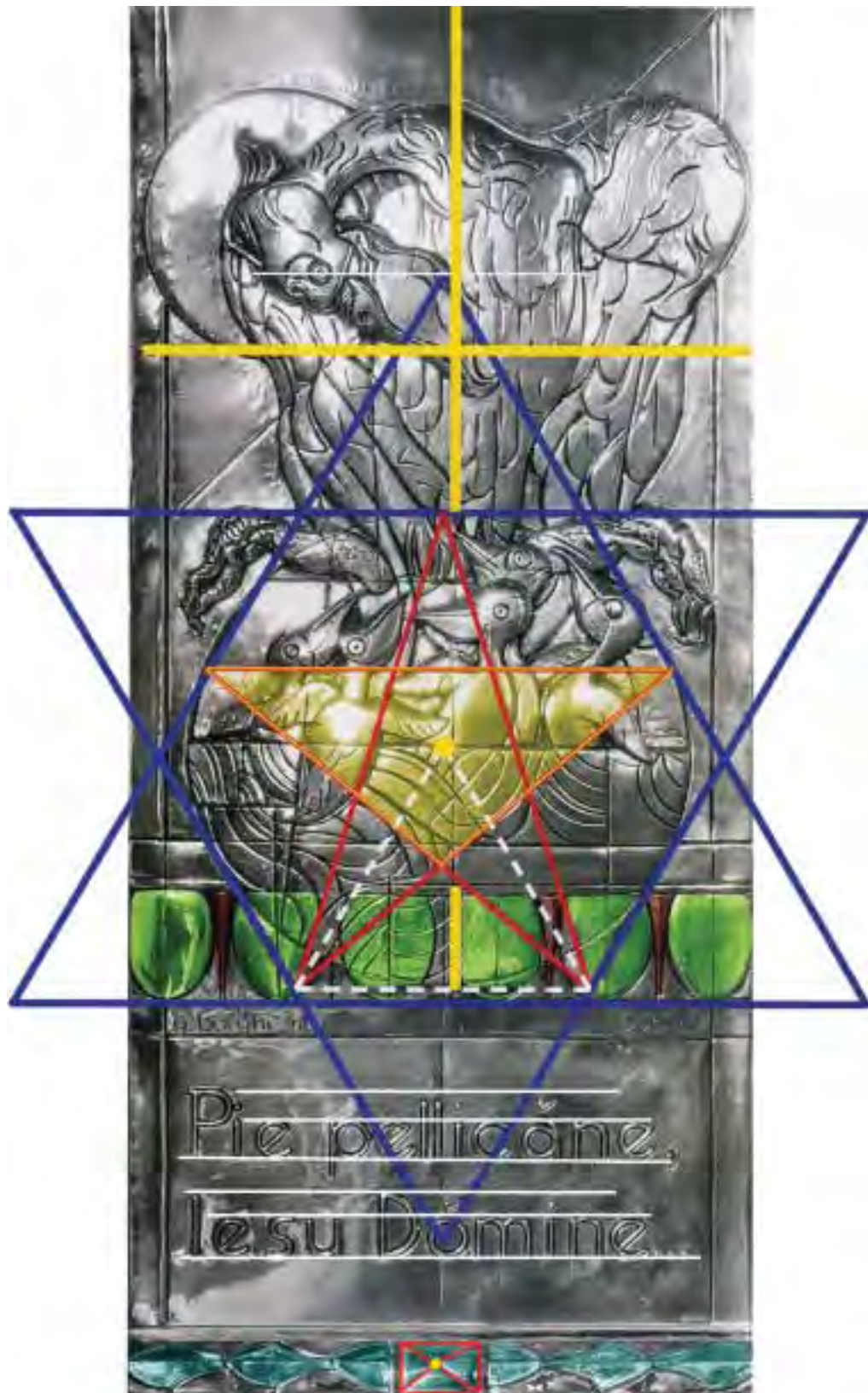

The 8 Eagles



«**T**he sculptor **Mario Rossello** was asked to carve, in the church-yard, “the flight of **eight eaglets** toward the Church”».

«The sculpted eagles are **eight** because **eight** is the number indicative of Easter». In the “**Dictionary of Symbols**”, we read: «The symbolism of the eagle involves also a **evil aspect**; the eagle is the cruel bird of prey, the captor. Sometimes, being associated to the various aspects of imperial power is also **symbol of pride and oppression**. It is the **perversion of its own power**».

Reads **Troisi’s “Masonic Dictionary”**, at the call “**eagle**”: «in Dante’s poem the **references to the eagle** are frequent, such as, for example, **as representative of the Roman emperors who persecuted the Church**». And again: «**In Freemasonry, the symbol of the eagle appears in the High Degrees starting from the 30th...**».

In fact, the symbol of a **two-headed eagle** appears in the **30th** degree; in the **32nd**, there appear **two two-headed eagles**, and in the **33rd** degree there is **one two-headed eagle only: total heads = total eagles : eight**.

Pure coincidence? It seems not!



Observing the disposition of these **8 eagles**, one observes that they are placed upon **two different levels** and in **three positions**, one next to the other.

Numbering the eagles, of the bottom left space, attributing the values from **1 to 3**, forming a triangle; then re-numbering, with **1 and 2**, the two eagles in the two bottom spaces adjacent to the previous one; and from **1 to 3** the eagles at the top, beginning from the left, **one obtains the key** to discover that **these eagles belong in fact to the three mentioned Masonic degrees**.

In fact, the first group of **3**, bottom left, indicates **30 = 30th degree**; remaining at the same level, and adding the **2** other eagles, one obtains **32 = 32nd degree**; adding to **30**, the **3** eagles of the higher level, one obtains **30 + 3 = 33 = 33rd degree**. Moreover, from the heraldic emblems of these degrees, illustrated in the following page, one observes that the eagle with the raised wings is that of the **33rd degree**.

In fact, the two eagles with the raised wings correspond to the “**third**”, amidst a group of three, and to the “**third**” from the left, of the higher level: **3 + 3 = 33rd degree**.



33rd degree: "The Man King"

«The degree teaches that **one must destroy every Religion and every Authority**. The passwords are: "**Ordo ab Chao**", motto of **Lucifer**, and "**Deus Meumque Jus**" (D.M.I.), motto of the High Initiates. Lucifer created **moral Chaos** with his rebellion against God, and the **Order** he has brought about is the **organization of Evil** and the recruitment of all those whom he has perverted in order to propagate his revolt and his hatred against God.

The **D.M.I** motto of the High Initiates means, instead:

- **Destruction of the Catholic Church**, of **Antimasonry** and of all that which **Materialization** does not reach;
- **Materialization** of the **Consciences**, of the **State**, of **Teaching**, through disorder, corruption, ambition;
- **Imposition** of the Masonic doctrine on the **Family**, on the **Nation**, on Humanity, through boldness, cunning, violence.

In this manner the hope of the **fallen Synagogue** will be effected; only thus, **will Lucifer see his own ambition satisfied!**».

(Meurin, cited work, pp. 386-387).



32nd degree: "Sublime Prince of the Royal Secret"

«This is the **Jewish degree** par excellence: that of the **Exile: sorrow, hatred, rage!** But the exile of Israel is but an image of the exile of **Lucifer**. The general idea of this degree is the march toward the **Holy Land** to reconquer it and **rebuild the Temple**. It is **the political unification of the World**, through **religious unification**».

The hatred is directed toward the **Church of Christ** that must be annihilated, and the weapon used is the **Great Pantheistic Lie** of the eternal transformation of the universe, from which derives the **self-deification of man** and the edification of a **New Tower of Babel**.

«**To destroy Christianity... we feign we are the only ones to have the true Religion... This means to deliver mankind from every religion is but a pious fraud**».

(Meurin, cited work, pp. 372-384).



30th degree: "Knight Kadosch"

«The Mason, in this degree plunges himself into an **all out war against God!** He is, however, warned that no one rises to this degree without **performing a sacrifice** to the object of his "**Cult**".

After kneeling and lowering his banner **before the image of Lucifer, the "Baphomet"**, he offers him the sacrifice of the scented incense, and then addresses this prayer to him: "O omnipotent Sapience, object of our adoration; it is you in this moment we invoke. Supreme cause of the Universe; eternal Reason, Light of the spirit, Law of the heart, **how august and holy your sublime cult!...**"».

The climax of the **Satanic hatred against God** is well expressed by the symbolic gesture of the **Knights Kadosh**: they wield the dagger against heaven, chanting their canticle, and terminate by repeating their entreaty to **Lucifer: "Holy God, Vindicator!"** and their challenge to God: "**Revenge, Adonai!**"».

(Meurin, cited work, pp. 361-366).



the mysterious ... stone CROSS

provides the drawings of the project, complete with front and side view of the great stone cross.

Something precise, at last!

The drawings are so reduced in scale, that the elevations are hardly readable, and some are unreadable altogether. With the magnifying glass, with computer graphics magnification and plenty of patience, one can finally obtain some data... about the “careful preliminary design studies”:

- base square: side **250** cm;
- height of the 54 vertical “stones”: **72** cm;
- height of stone at arms crossing: **80** cm;
- total height of cross = **3,968** cm;
- upper side 54th stone at vertex = **42** cm;
- n. of vertical “stones” = **55**;
- n. of “stone” in each arm = **5**;
- n. of stones of upper arm = **7**;
- arms width at upper point = **4.5** m;
- arms width between upper point-axis = **4.86** m;
- arms width between lower point-axis = **4.97** m;
- arms total width = **9.94** m.

Leaving aside the discordances with the data already viewed, we felt we were in a dream nonetheless... but the dream was short-lived: observing the crystal-clear photograph of the upper part of the cross, we discovered that **the number of the “stones” of the side arms and of the upper one were different from those of the project: 7 instead of 5, for the side ones; 8 instead of 7, for the upper arm!**

So long! cross height; so long! arms height... We realized it was no longer a matter of approximation or inability... **there had to be a mystery!** And the presence of mysteries in technical matters, relative to the construction of a cross, after “**careful preliminary design studies and the drafting of a manual in order to ensure the quality of execution**”, has aroused our curiosity to the point that we decided to proceed in another manner: first, to discover the mystery; then, to identify the actual dimensions of this **mysterious cross!**

“The stone cross, scale of the destinies of the world”, thus introduced in book “*Pietre di bellezza e di santità*”, *Stones of Beauty and of Sanctity*, of the Capuchin Friars, is a cross located at the end of the main pedestrian lane. **«The great glorious cross without crucifix, yet scale of the destinies of the world, designed by the same architect Renzo Piano... is over 40 meters high, with a variable cross-section of 2.50 x 2.50 m. at the base up to 0.40 x 0.40 m. at the top. In the upper part are inserted two horizontal arms, narrowing outward, 4.50 m in length. It is composed of 65 large cubic stone blocks all different from each other».**

The Capuchin Friars assure us that «... The great cross required careful preliminary design studies and the drafting of a manual in order to ensure the quality of execution».

The work: “*La chiesa di Padre Pio a San Giovanni Rotondo*”, *The church of St. Padre Pio at San Giovanni Rotondo*, by Maurizio Oddo, points out to us that «Not satisfied with so much toil, Renzo Piano and Mons. Valenziano, liturgical consultant, thought of erecting the great cross, 40 meters high with 10 m wide arms, built entirely in stone with overlaying and pre-compressed elements, completing this unprecedented work». Oddo, without wasting time in descriptions about the great cross, gives us a precious present: at page 86 and 87, he

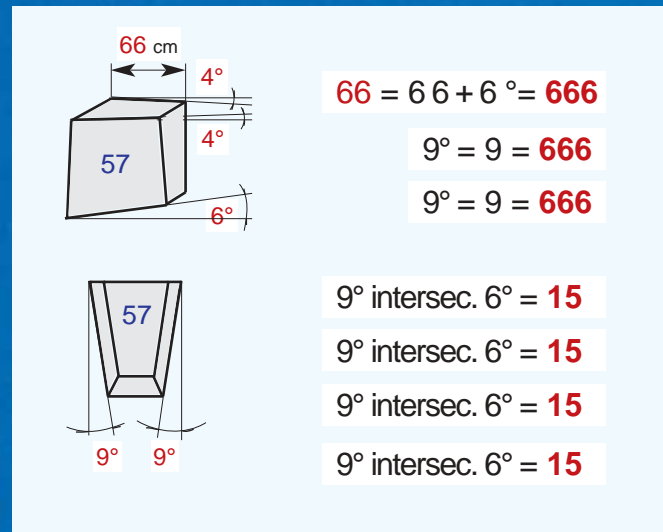
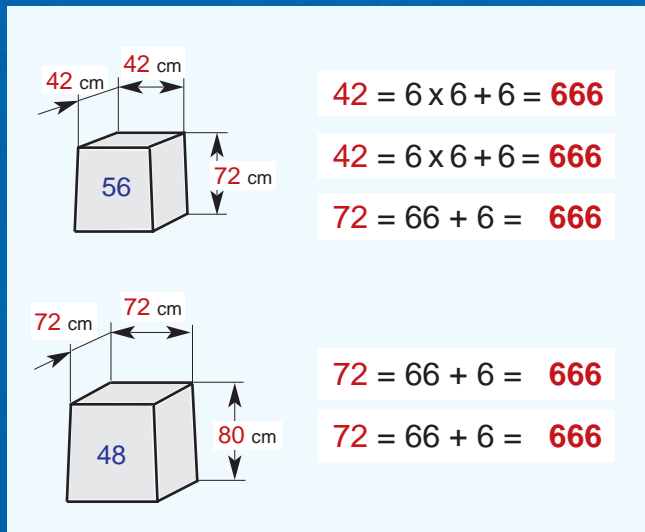

Side arm: 7 "stones"

Side arm: 7 "stones"

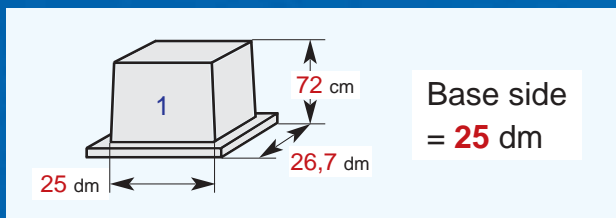

Upper arm: 8 "stones"

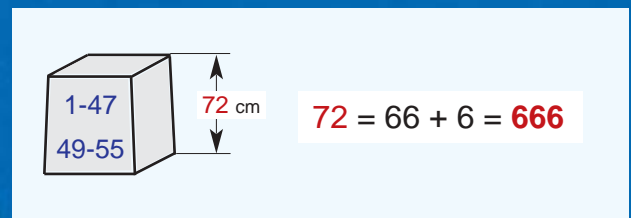

The upper part of the 40 m cross, viewed from the South. As the photograph clearly shows, the "stones" used in the two side arms are 7 and not 5, as per design; whereas those used in the upper arm are 8 and not 7, as indicated in the project blueprints.

Observing the photo of the upper part of the cross, one observes that the lines of the stones of the two side arms are not parallel, but converging. Where do they converge? To a 50 meter elevation!

The "Dictionary of Symbols" (p. 89) says: «50 is the number of Redemption!» With what already dug up, we were certain it was not about the Redemption of Christ, but that of Lucifer! We thought at once that 50, and that is, 5, would also indicate a "5-pointed Star".

The first verification was that of the 2 angles at the vertex of the square base pyramid of the vertical column; the result: 3°. The sum of the two angles: 3° + 3° = 33, the degrees of the Freemasonry of the A.A.S.R.

Knowing that the vertical stones were no longer 55, but 56 (with the upper arm of 8 stones), with all the stones of height 72, less the cross stone of the two arms with a height of 80 cm, we calculated the height of the cross: 40.40 meters.

The "Dictionary of Symbols" says: «40 is the number of the wait, of repentance, of the trial of the punishment...», precisely that which is required for a "Redemption".

Hence the height of each stone was con-

firmed to be 72 and 80 cm, whereas the side of the square of the 56th stone, the last one at the top, was marked on the project: 42 cm.

The numbers 72 and 42 are not new to us: they both indicate 666: $72 = 66 + 6 = 666$; whereas $42 = 6 \times 6 + 6 = 666$; besides, 72, we had seen, is the number expressing Masonic ecumenism, while 42 were the 42 Demons, the "Lords of the Truth" and the "Judges of the dead" of Osiris, the "Great Deity of hell", whose "Eye in the triangle" indicates Lucifer.

Now, all the stones of the vertical column are truncated square-base pyramids converging to elevation 50 m, hence they are "pointed cubic stones", and represent the number 7, symbol of the "Master", the "perfect stone", the "true man", the "divinized man" of Freemasonry.

One could object that, among all the stones of the cross, there is not a single cube; in addition, they are all different from one another. The "perfection", that is, the "cubic" shape of all these stones, however, is not represented by their actual dimensions, but by the number 666, the "spiritual" "perfect cube" of the Antichrist: they are the "stones of the Antichrist"!

The 48th stone, crossing point of the two

arms, from graphical verifications has resulted to have the side of its upper square of 72 cm. The difficulties, however, have aroused in defining the dimensions of the 14 stones of the two side arms, in order to verify their attribute of "perfect" cubic stones.

The three project elevations of the width of the two arms lost their reliability for the reason that the stones are no longer 5, but 7. Always through graphical verifications on photographs, we found the solution: all 14 stones have a width of 66 cm, with angles of vertical conicity of 9° and horizontal angulation of 6°, whereas the outward narrowing angle of the two arms is of 4° on either side; all these angles correspond to those reported in the detailed drawings of the project.

As detailed in the boxes of the photograph above, we observe that not all the stones have the same "valence" of impiety: they are all worth 1 time 666, with the exception of the 48th which is worth 2 times 666; the 56th and the 14 of the side arms, instead, are worth 3 times 666.

The "stones" used, overall, are 70, while the total of the 666 is 101.

What do the numbers 7 and 70 characterizing the symbology of the "stones", mean?

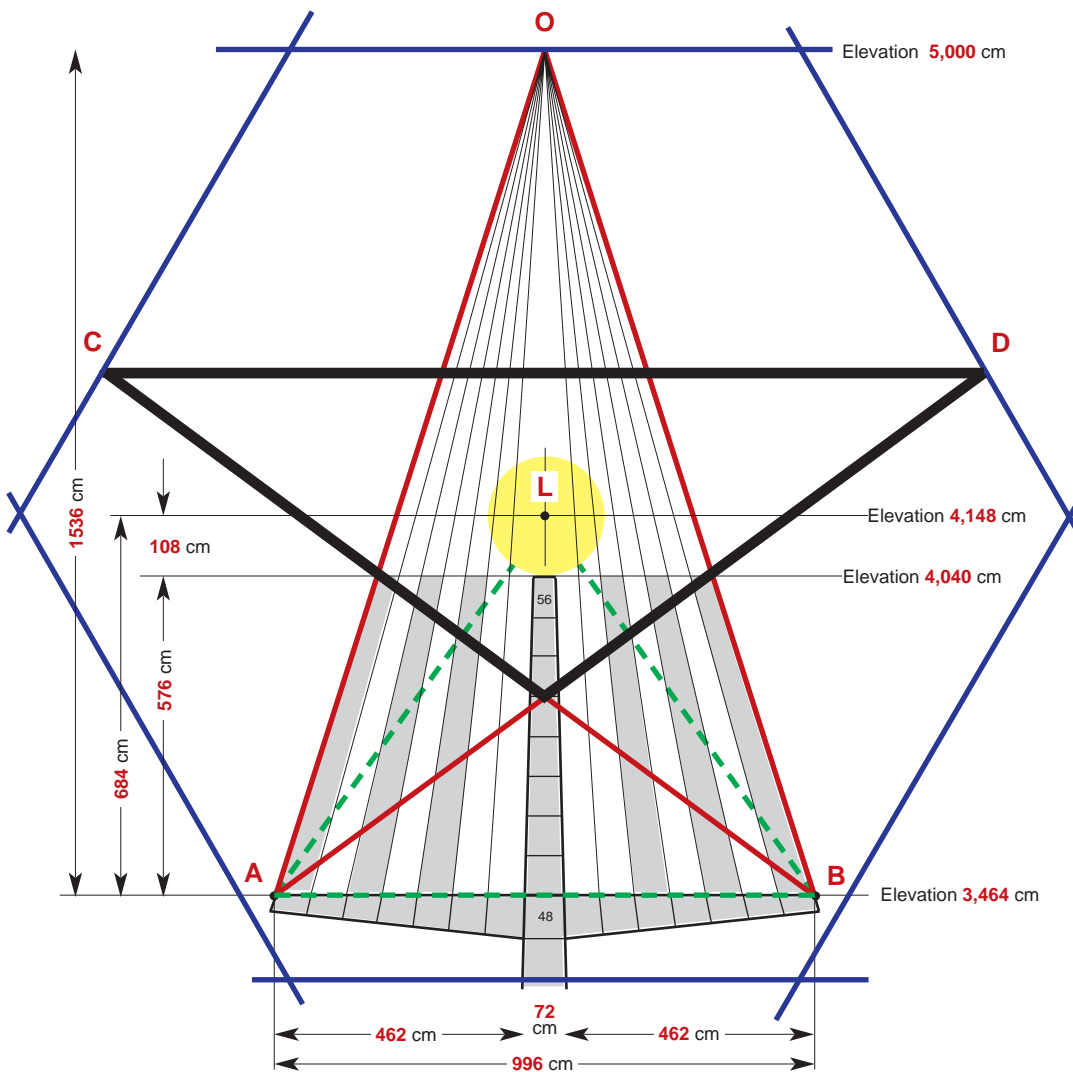

Construction of the "5-pointed Star" and of the center of the "Upturned Triangle".

Reads the "Dictionary of Symbols": «7 is the number of the **perfect man**, that is, of the perfectly accomplished man... The number **7** indicates the **totality**... principally on the **spiritual level**. According to the **Talmud**, the Jews saw in the number 7 also the symbol of **human entirety**...

Chapter 10 of Genesis enumerates **70 peoples** of the earth that were scattered after the construction of the **Tower of Babel**... the number **70**, as a multiple of **7**, indicates the **idea of entirety**...»¹.

Are these **70 "stones"**, each of which, in the number **7**, represent the "**divinized man**" of the Lodges, and representing the **entire humanity**, perhaps the **70 peoples** (the entire humanity) scattered by God which are reunited by Freemasonry to rebuild, in hatred to God, a "**New Tower of Babel**"?

Does the evocative number **5**, of elevation **50**, symbolizes a "**5-pointed Star**"? Yes! The three points **A, B, O**, of which we know elevations and distances, constitutes the triangle that defines in an univocal manner a "**5-pointed Star**" with side measuring **AO**. Tracing the sides **AD** and **BC** with equal length and angles of **36°** and **144°**, one obtains the Star with center in point **L**.

Now, tracing a circle with center in **L** and radius such as to graze elevation **40.40 m** of the summit of the stone cross,

one finds that such a radius is of **108 cm**, which, kabalistically, means $1 + 8 = 18 = 666$ and $108 = 6 \times 666$, in total: **7** times the "**Mark of the Beast**", divided into **1+6**.

Reads the "Dictionary of Symbols" (p. 375): «An Hindu tradition attributes to the **Sun 7 rays**: **6** corresponding to the directions of space, the **7th** corresponding to the center...».

On the stone cross, we had **70 "perfect stones"** totalizing **101** times **666** to which, now, is added another "**stone**" worth **7** times **666**, with a total of **108** times **666**, the same number of the radius of the **central circle** to the "**upturned Triangle**", symbol of the **Masonic "Holiest and Indivisible Trinity"**.

What does that circle, then, represent? **It is the All-seeing Eye of Lucifer inside the Triangle!**

One curiosity: speaking of the occult meanings of the **Meditation Room at the UN**, Spenser writes: «on February 16, 1953, the "**Group of Friends of the Meditation Room at the UN**" (**1,500** members), presented the "**Guest Books**" of the **Room**, where everyone could enter his name, address, and practiced religion. Between October and June of 1963, circa **4 million** people visited the **Meditation Room**, and over **750,000** of these signed **108** of these signed **7,000** names»².

Let us continue the construction of the **stone cross**: let us trace a straight horizontal line at elevation **5,000 cm** (point **O**) and two more at **60°** and **120°** passing through **C** and **D**; with center always in **L**, let us construct the "**6-pointed Star**", reproduced in full at page 57. The construction is now complete: they are the **1st, 2nd and 3rd Masonic "Holy Trinity"**, the very construction already seen on the **Tabernacle**. Is it, indeed, the same one?

The meaning appears to be different: the "**Triple Trinity**" on the Tabernacle regarded the "**Man Redemption**" of the **single individual**; now, instead, this "**Redemption**" of **Lucifer** is extended to all the **70 peoples** representing the **entire divinized humanity** that, organized by Lucifer, throws itself against God, with the renewed impiety of willing to rebuild the **Temple** of the "**New Tower of Babel**".

The "**stone cross**" represents another particularity as well: it exposes Freemasonry's worldwide hierarchical structure: the side of **25 dm** of the **1st stone**, indicates the **Scottish Rite of Perfection**, whence the **Freemasonry of the A.A.S.R.** was born in 1801 (first **33 stones**); the **34th "stone"**, indicates the "**New Reformed Palladian Rite**", founded by **Giuseppe Mazzini** and **Albert Pike** in 1870; the **22 stones**, from the **35th to the 56th**, indicate the **High Jewish Freemasonry of the B'nai B'rith**, whose symbol is a "**Menorah**".

The **7 "stones"** of the side arms have the particularity of representing, together with the **48th** at the center, **7 Tetragrammaton**:

- **48th**: $h = 80$, upper sides = 72×72 ;
- each of the **7** stones of each arm has the following angles: **2** of **9°** intersecting with one of **6°**, forming **4** points of intersection of value **15**. Taking two symmetrical stones with respect to the central one, one obtains the **8** numbers **15** of the **Tetragrammaton**. Each side block, besides, contains the numbers **4** and **8**; in fact, the outward narrowing angles of the arms are of **4°** on either side.

What do these "**stones**" whose valence of impiety is **3** times **666**, symbolize?

Using the lines of convergence on the point of elevation **50 m**, intersecting them with an horizontal straight line at elevation **40.40 m**, one obtains **7 sectors**, on either side, plus the **central** one of the stone cross.

Taking the **central sector** and the **3** side ones of odd numbers **7, 5, 3**, and joining them with the transversal arm of the cross, one obtains an **immense "Menorah"**, nearly identical, in the shape, to that which symbolizes the **High Jewish Freemasonry of the B'nai B'rith** (see photograph at p. 56).

The representation of this "**Tower of Babel**" is completed by the "**Sun of Lucifer**" with "**7 times 18 rays**", numbers that symbolize the "**infinite totality of heavenly perfection**"... **Satanic, that is!**

¹ J. Chevalier, A. Gheerbrant, "Dictionary of Symbols", pp. 373-380.

² R.K. Spenser, cited work, p. 11.

The Temple of the “Ecumenical Counter-Church” of the Antichrist

Reads the “**Dictionary of Symbols**”: «**40** marks the fulfillment of a cycle, which must not lead, however, to a mere repetition, but to a **radical change**, to a passage to an order of action and life». And again: «**40** is the number of the waiting, of the trial, of the preparation, of repentance, of punishment»¹.

There come to mind the words of the famous Jewish professor **Jean Izoulet** (theorist creator of the UN), who in his work “**Paris capitale des religions, ou la mission d’Israele**”, wrote: «**Christianity is a mosaic unconsciously camouflaged for use in the pagan world and which, in that manner, has conquered to Israel 650 millions souls. Today, the disguise disappears, and Moses appears as the one and only chief of the fundamental religion; as the one and only chief of the civic and scientific religion; as the one and only chief, at last, of the secular religion**»².

The Jewish Grand Master **B. Crémieux**, speaking of the **fusion of the various world religions under the high Jewish inspiration**, said: «the times are come when... the most wonderful of Temples, a Temple whose stones are alive and endowed with thought, raises to welcome... under the flag more and more sacred of reason and of philosophy, all that mankind holds in its noble breast, of hostile to mystery and ignorance, of worthy of the true sons of light and freedom. **This Temple will host the Hebrew religion, which survived everything... a religion that is vast and worthy of the entire humanity**»³.

Jean Izoulet, in the same quoted work, went on to write: «The idea of progressive unification of the globe is an idea on the go. It is bound to the idea of religious unification since Religion is the very essence, as it were, the double, triple, fourth, fifth essence of politics. One must come to the sound and holy secularization of our Western churches, that is, to the world Religion that will found the Mystic Unity and, consequently, also the political Unity of

¹ Cfr. “**Dizionario dei simboli**”, *Dictionary of Symbols*, Ed. Dizionari Rizzoli, vol. II, under the call “**4**”, p. 266.

² Cfr. Jean Izoulet, “**Paris capitale des religions, ou la mission d’Israele**”, Ed. Albin Michel, Paris 1926, p. 184.

³ Cfr. “**Libertaire**” of New York, 1902, Di 402.



The “stone cross” is a representation of the “**Temple of Solomon**”, or “**Masonic Temple**”, the Temple the Jewish Grand Master **B. Cremieux** so described: «The times are come when this Temple... the most wonderful of Temples, a Temple whose stones are alive and endowed with thought, raises to welcome... under the flag more and more sacred of reason and of philosophy, all that mankind holds in its noble breast, of hostile to mystery and ignorance, of worthy of the true sons of light and freedom. **This Temple will host the Hebrew religion, which survived everything... a religion that is vast and worthy of the entire humanity**».

Do the **8** bells with the **9** columns housing them indicate, perhaps, that the **sound of the bells of Masonic ecumenism** must resonate in the **8** directions of the “**Magic Square**”? And does the product **8 x 9 = 72** indicate, perhaps, that this sound expresses all of the **72** names of the Kabalistic **God-Lucifer**?



Above: a "Menorah" in a Synagogue.

Below: the "Menorah" of the symbol of the High Jewish Freemasonry of the B'nai B'rith.

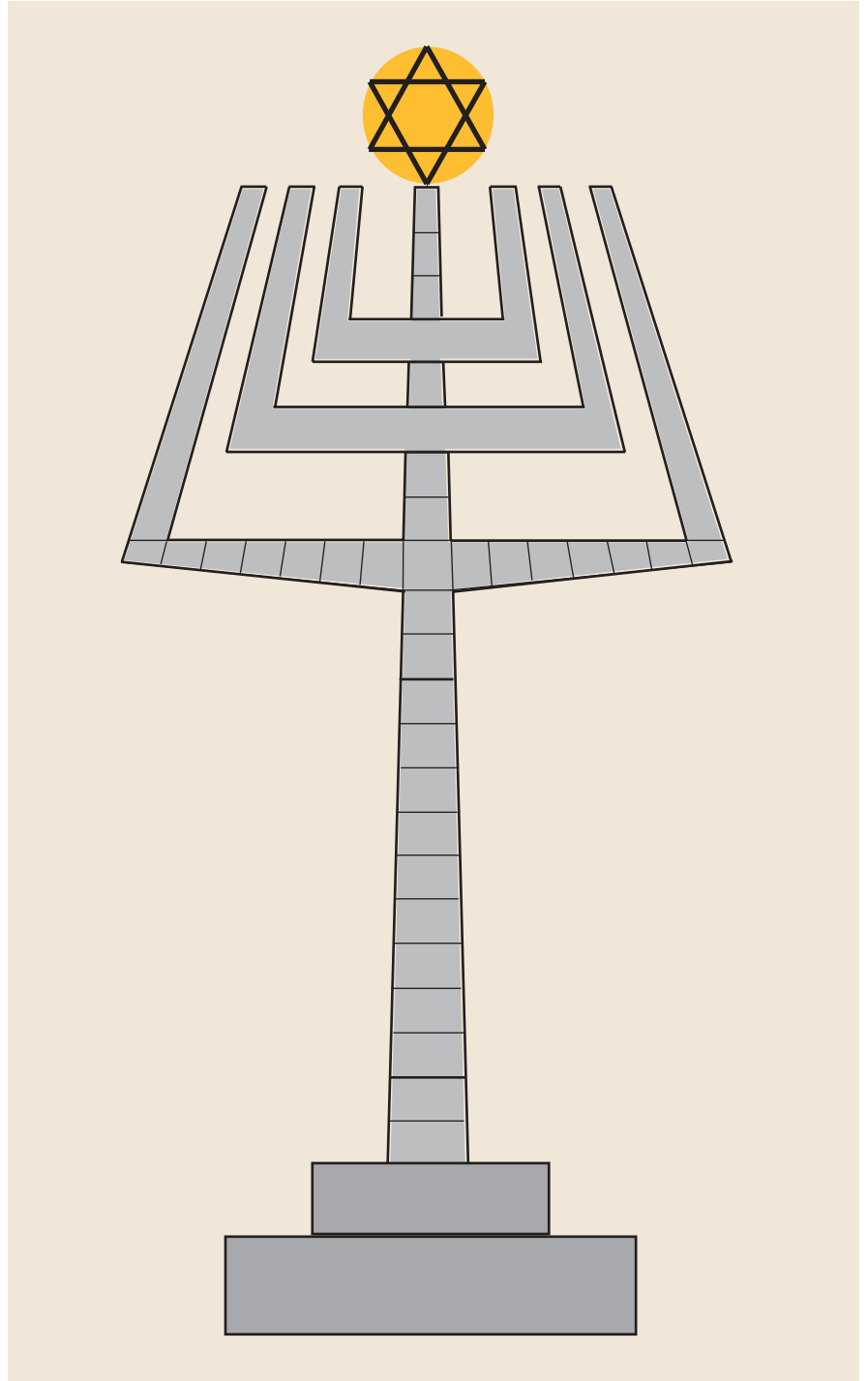

The gigantic "Menorah" which is obtained by the symbolic elaboration of the 40 m high cross, as by extracting from the overall symbology only the portion above the 34th block, which represent the Jewish Freemasonry.

mankind. And the spiritual and temporal hegemony of Humanity will lawfully belong to that race... and to its Religion, the most authentically and substantially divine...»⁴.

Here you have the "UPTURNED TRIANGLE" of the Masonic and Satanic 'HOLDEST AND INDIVISIBLE TRINITY" towering on top of the stone Cross 40.40 meters high: Lucifer, the self-styled "infinite Sun" flanked by the two crowned heads of the eagle: the Great Patriarch of the World, or Director of Spiritual power, and the Great Emperor of the World, or Director of temporal Power. Here you have Lucifer who, after the

declaration of war on God, launched by Jewish Freemasonry, symbolized by the 3 times 666 of the 56th stone of the Temple, launches on God the challenge of his blasphemous "Triple Trinity", symbolized by the 9 times 666 emanating from the solar Center, from Hebraism ("6-pointed Star") and from Freemasonry ("5-pointed Star"), completely incorporated into the "mystic Body of Lucifer" and elevated to the vertex of the Temple of the Ecumenical Counter-church of the Antichrist!

The Masonic "dogma" of fighting the supernatural, namely, God, in the Three Persons of the Father, of the Son, and

of the Holy Spirit, and the replacement of Jesus Christ with Lucifer on the Cross of Redemption, calls for the annihilation of the "Church of Christ", and the weapon used is Masonic Ecumenism.

Only thus will Satan be able to offer his Redemption: when «men will receive the true light, through the universal manifestation of the pure doctrine of Lucifer, finally revealed to the public eye»!

⁴ Cfr. Jean Izoulet, cited work, pp. 50-52.

THE TEMPLE OF THE "ECUMENICAL COUNTER-CHURCH" OF THE ANTICHRIST

50 is the symbol of **Redemption**

Lucifer is «the "pointed cubic stone" tossed by Jehovah into the abyss to create the world». Lucifer wants to replace Christ on the Cross, and offer man his "Redemption": freedom from sin, and has founded his Church (Freemasonry) to incite man to rebellion against God, to get rid of God, replace God, fight God. Freemasonry obtains this by fighting Virtue, Morals, and Catholic Authority in the world and by replacing the Kingdom of God of the Catholic Church with the Kingdom of Satan of Freemasonry.

Lucifer wants the "Cult of Lucifer" in the public view, and Universal Freemasonry's Pontiff Pike, who belonged to its "Holiest and Indivisible Trinity", proclaimed this; but that will not be possible until when the Sacrifice of Christ on the Cross will have been completely erased: that is the task entrusted to the 18th degree of the Rose Croix. Moreover, 18 is the "Mark of the Beast" 666 and of the Antichrist, but it also symbolizes (Satanic) "heavenly Perfection", whereas 7 is the number of totality. Here is the reason of the 7 times 18 rays around the "Infinite Sun" of Lucifer!

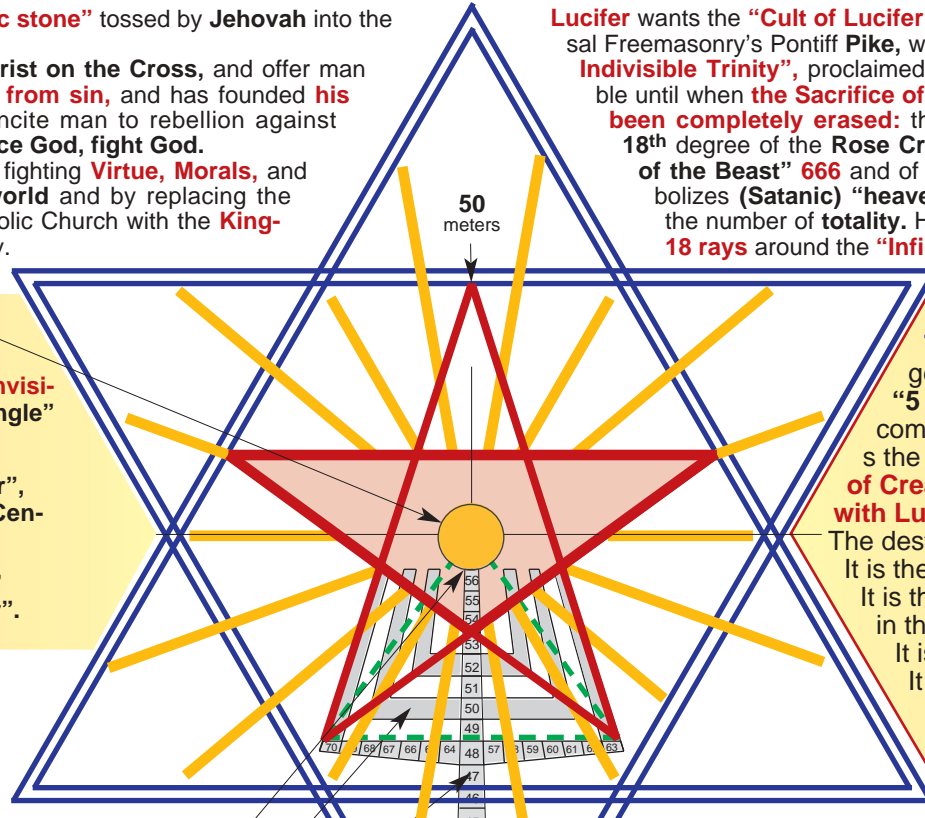

"Infinite Sun" of Lucifer.

3rd "Trinity": "Holiest and Invisible Trinity": "upturned Triangle" with the "Central Point".

2nd "Trinity": "6-pointed Star", "5-pointed Star" and the "Central Point".

1st "Trinity": base "Triangle" (green) of the "5-pointed Star".

The "5-pointed Star" is the perfect image of the DIVINIZED HUMANITY.

The "base Triangle" (green) is the image of the DIVINIZED MATTER.

The universal axis: in this geometry, the axis is that of the "5 and 6-pointed Star": the truth communicated to man by Lucifer is the "divinization of Humanity, of Creation and of the Matter", with Lucifer at the Center. The destruction of Catholic Authority. It is the "Cult of Lucifer". It is the 3rd temptation of Christ in the desert: "power". It is "man fighting God". It is the aim of the 3rd series of the 11 degrees of the A.A.S.R..

Lucifer replaces Christ as King of the Universe!

The "6-pointed Star" is the perfect image of DIVINIZED CREATION.

40.40 m: it is the symbol of waiting, trial, and punishment.

Menorah: symbol of the B'nai B'rith.

High Jewish Freemasonry of the B'nai B'rith.

34th stone: "New Reformed Palladian Rite".

33 degrees: "Ancient and Accepted Scottish Rite" (A.A.S.R.).

25 degrees of the "Scottish Rite of Perfection" whence the A.A.S.R. was born with the addition of the 8 degrees of the Order of the Illuminati of Bavaria.

The 14 stones of the two side arms are always "pointed cubic stones", as they converge to the vertex of 50 m, and have: Length = 66 + 6° (arm's lower angle) = 666
2 side angles of 9° = 2 x (9 = 1 + 8 = 18 = 666) = 2 x 666

The height 72 of the stones expresses the number of the Antichrist 666.

The two angles at the vertex (50 m) of 3° of each stone indicate 33, namely, the Freemasonry of the A.A.S.R.

The height of the 54 "perfect stones" of the column of the cross, of 72 cm, expresses the 72 Names of the Kabalistic name of God (namely, of Lucifer) in the ecumenical reunion of all the religions of the earth.

The "New Tower of Babel"

«Chapter 10 of Genesis enumerates 70 peoples of the earth that were scattered after the construction of the Tower of Babel». Masonic Hebraism intends to reunite these 70 peoples (there are 70 stones in the cross) in order to build the "Temple of the Ecumenical Counter-church of the Antichrist", which is the "New Tower of Babel".

The 1st stone has the side of the base square of 25 dm.

The central circle of radius 108 and the two Stars represent 9 times 666 (the Triple Trinity)

108 = 1 + 8 = 18 = 1 x 666
108 = 6 x 18 = 6 x 666
6-pointed Star = 1 x 666
5-pointed Star = 1 x 666

Total = 9 times 666

The number 666 of the cross:

54 stones: 1 x 666 = 54 x 666
48th stone: 2 x 666 = 2 x 666
56th stone: 3 x 666 = 3 x 666
14 side st.: 3 x 666 = 42 x 666
Radius circle = 108 = 6 x 666
Center circle = 108 = 1 x 666

Total = 108 times 666

56th stone: 5 + 6 = 11 = Jewish Freemasonry
3° + 3° = 33 = Freemasonry of the A.A. Scottish Rite

Height: 72 = 66 + 6 = 666

Upper sides: 42 x 42 = 2 (6 x 6 + 6) = 2 x 666

Total: 3 x 666 (The Masonic Hebraism declares war on God).

The 48th central stone with the two side arms of 7 stones each, form 7 Tetragrammaton, or 7 "Magic Squares":

The square is that of side 72 x 72 of the 48th stone

The 8 directions are expressed by the height 80 of the 48th stone; The 8 n. 15 for each "Square", are obtained as sum of the 2 side angles of 9° with the lower angle of 6° of each side stone, which form 4 intersections of 9 + 6 = 15.

48th stone: Upper sides 72 x 72 = 2 (66 + 6) = 2 x 666

The sides 72 x 72 and the height = 80 indicate the Tetragrammaton. 72 = 7 + 2 = 9 9 x 8 = 72 2 x 72 = 2 x (66 + 6) = 2 x 666.

The stones used to build this Temple are the 70 "pointed cubic stones", each represented by the n. 7, which is the number of the "Master", the "perfect man", the "perfect Stone".

The "perfection", the "cubic" shape of all these stones, notwithstanding their diversity, is represented by the number 666. The stones, therefore, are not "the angle stone discarded by the constructors", that is, Jesus Christ, but precisely the opposite: the Antichrist!

The 33 DEGREES of the Ancient and Accepted Scottish Rite

«The true division of the 33 degrees into 3 series of 11, is only found in the most secret instructions, outside the 33 degrees, and in the symbols, under which the true Masonic secrets are “impenetrably hidden”»¹. One of these documents is the “Secret Instruction given to general Giuseppe Garibaldi” on the occasion of his promotion to Chief of Freemasonry. This document, one of the vividest lights ever to emerge from the darkness of Freemasonry, with all the Authority of the Hidden Chiefs of Freemasonry, exposes, in a clear and unequivocal manner, the real meaning of the subdivisions of the 33 degrees of the Ancient and Accepted Scottish Rite, into the three series of eleven.²

Here is an excerpt of the document:

«(...) in our Order, no degree reveals completely the Truth; it merely makes less thick the veil that hides it from the prying gaze. To us, invested with the supreme power, and to us only, does it unveil it entirely, and, by flooding our intelligence, our spirit and our heart, it makes us know, see and hear that:

Man is, at one time, God, Pontiff and King of himself. (...).

Hence **Freemasonry**, perfect synthesis of all that is human, is **God, Pontiff and King of Humanity; (...)**

As for us, grand chiefs, we form the Holy Battalion of the Sublime Patriarch, whom, in turn, is God, Pontiff and King of Freemasonry.

Here, Brother, is the third triangle, the third triple truth that will give your intelligence, your mind and your heart the ineffable happiness of the absolute possession of the Truth without veils! The entire Organization, functioning and teaching of the Order, appears now to your eyes, Brother, beaming with clarity, and you see, you comprehend that all our teaching finds its fulfillment in this: **to restore the triumph of our Virtue, of our Morality and of our Authority throughout the whole of Mankind.**

For that, our degrees have a triple classification, depending on whether they are called to fight that which our implacable adversaries, our mortal enemies, our infamous persecutors, the clerical, dare call: their **Virtue**, their **Morals** and their **Authority**.

In order to fight their abject Virtue, we have the degrees: 1st, Apprentice; 2nd, Fellow; 3rd, Master; 4th, Secret Master; 5th,



Giuseppe Garibaldi with the 33^d degree of A.A.S.R.

Perfect Master; 6th, Intimate Secretary; 7th, Provost and Judge; 8th, Intendant of the Building; 9th, Elect of the Nine; 10th, Elect of the Fifteen; 11th, Elect of the Twelve; which allows us to lead a profane from the unawareness of the “Apprentice” up to the mission of “Elect of the Twelve”, for the defense of Masonic virtue, for the crusade of Man, God of himself (...).

In order to fight their foul Morals, we have the degrees: 12th, Grand Master Architect; 13th, Royal Arch of Solomon; 14th, Grand Elect Perfect and Sublime Mason; 15th, Knight of the East; 16th, Prince of Jerusalem; 17th, Knight of the East and West; 18th, Knight Rose Croix; 19th, Grand Pontiff; 20th, Master ad Vitam; 21st, Patriarch Noachite; 22nd, Prince of Libanus (...).

In order to fight their guilty Authority, we have the degrees: 23rd, Chief of the Tabernacle; 24th, Prince of the Tabernacle; 25th, Knight of the Brazen Serpent; 26th, Prince of Mercy; 27th, Commander of the Temple; 28th, Knight of the Sun; 29th, Knight of St. Andrew; 30th, Knight Kadosh; 31st, Inspector Inquisitor Commander; 32nd, Sublime Prince of the Royal Secret; 33rd, Grand inspector General (...).

The clerical, infamous assassins of humanity, oppose, you see it, Brother, to our Virtue, to our Morals, to our Authority, their Property, their Religion and their Law; and these are their mortal enemies of Freemasonry which you will fight from this time forth, as army commander (...).

Neither the Law, nor Property, nor Religion can thus impose

¹ Leone Meurin, cited work, p. 261. («All of our Masonic secrets are impenetrably hidden under the symbols», ref. Paolo Rosen, “Il Nemico sociale”, *The Social Enemy*, p. 297).

² The “Secret Instruction” was published by Paolo Rosen in his

book, “Il Nemico sociale”, *The Social Enemy*, and by Mons. Leone Meurin in his work, “La Framassoneria: sinagoga di Satana”, *Freemasonry: Synagogue of Satan*, Siena, 1895, pp. 261-266.

themselves to man; and because they annihilate him, depriving him of his most precious rights, they are assassins of which we vowed to draw terrible revenge; they are enemies on which we have sworn a relentless war, a war to the death!

Of these three infamous enemies, it is Religion that must be the constant thought of your assaults; for a people has never survived his Religion, and because, by killing Religion, we shall have in our hands Law and Property; because by establishing, over the cadavers of these assassins, the Masonic Religion, the Masonic Law, the Masonic Property, we shall have regenerated Society (...).

As our God is neither substance, nor body, nor soul, nor creator, nor father, nor word, nor love, nor paracletus, nor redeemer, and nothing, we have submitted the Church to the secular power and upturned the temporal power of the Pope, waiting for the disruption of his spiritual power.

Because we are the builders of the new Temple of the happiness of Mankind, and because in order to build it, it is necessary to commence from demolition, from the destruction of the current social State, we have suppressed religious teaching; we have suppressed the right of the peoples.

After having overthrown the temporal power of Pope, of our infamous and mortal enemy (...) our Supreme Chief will reign alone over the world, and, sitting on the steps of its throne, Freemasonry will share with him Omnipotence!...

Grand and dazzling it is this supreme aim that we have shown to you, but great and patient are the works and toils that are necessary to obtain it.

Today, as you seat among the Grand Masters, your works must increase in intensity, and to better point out to you their tendencies, assuring at one time their success and their triumph, we will clearly outline to you the Great Light of the supreme initiation: You are to yourself God, Pontiff and King. Your reason is the sole rule of Truth, the sole key to science and politics. Your appetites and your instincts are the sole rule of Good, the sole key of progress and happiness.

You must comprehend and interpret, as follows, our holy enterprise: «FREEDOM, EQUALITY, BROTHERHOOD».

FREEDOM, the omnipotent weapon with which we have disrupted the world, means:

- Independence, without limits and without restrictions, subtracted to any kind of authority;
- Independence of spirit, which could not be generated by any revelation, nor limited by any dogma;
- Independence of will, which will not submit to any power, which will recognize no King, or Pope, or God;
- Independence of personality, which has severed all the chains that enslaved it; physical and moral alike, chains of the earth and chains of heaven, in order to achieve the independence of humanity, toward its absolute and complete emancipation.

It is through Freedom, as a lever, and human passions, as a pivot point, that we will crush forever the Kings and the Priests, these implacable enemies of mankind, more fatal to humanity than the tiger to the other animals.

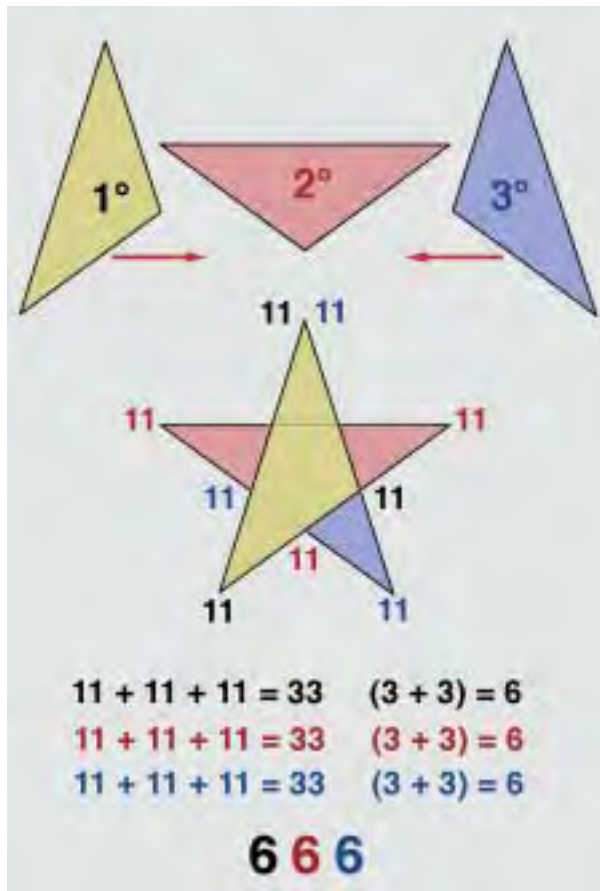

The "5-pointed Star", formed by the three triangles symbolizing the self-divinization of Humanity, of Freemasonry and the Masonic Leadership, in its numerical composition expresses, as sum of the three series of 11 degrees of each triangle, the number of the "Mark of the Beast" 666.

EQUALITY, the omnipotent level through which we transformed the world, means:

- Equality of properties, for man's rights of on the common earth, as a citizen of one and the same world, as the son of one and the same mother, are more ancient and more sacred of all the contracts and all the customs, and, as a consequence, these rights must be shattered, these customs must be abrogated;
- Equality of fortunes, with the proportioned equilibrium of salaries, with the complete and radical abolition of inheritance rights, with the expropriation of all financial Companies, with the appropriation to the national solidarity of each people, of banks, channels, transports, insurances and mines;
- Equality of individuals, through solidarity, through the equal enjoyment for each to one's own solidaritarian production.

It is through Equality, as a lever, and human appetites, as a pivot point that we will wipe out forever the Silver Aristocracy, implacable executioner of mankind.

BROTHERHOOD, the omnipotent promise with which we established our power, means:

- Brotherhood in Freemasonry, to build a State within the State, with means and functioning independent of the State, unbeknownst to the State;
- Brotherhood in Freemasonry, to build a State superior to the State, with a Unity, a cosmopolitism, a universality that make it (Freemasonry) superior, leader of the State;
- Brotherhood in Freemasonry, to build a State against the State (...);

It is through Brotherhood, as a lever, and human hatreds, as a pivot point that we will wipe out forever Parasitism and armed Repression, these plagues as yet unchecked, these fierce bugbears of mankind.

Brother, here is the term of your instruction as Chief of Freemasonry. And now, take with us the Supreme Oath:

- I vow to have no homeland other than the Universal Homeland.
- I vow to fight relentlessly, always and everywhere, the boundaries of the nations, the boundaries of the fields, of the houses and of the factories, and the boundaries of the family.
- I vow to shatter, sacrificing my live, the boundaries where humanicides have traced, with blood and with mud, the name of God.
- I vow to sacrifice my existence to the indefinite triumph of progress and of universal unity, and I declare to profess the repudiation of God and of the soul!

And now, Brother, that the Nation, Religion and the Family have disappeared forever, for you, in the immensity of the work of Freemasonry, come into my arms, Most Powerful, Most Illustrious, and Dearest Brother, to share with us the unlimited Authority and the boundless enjoyment that we exert over Humanity»!

SUMMARY OF THE 33 DEGREES OF A.A.S.R.

The “**Patriarch of Universal Freemasonry**”, **Albert Pike**, concerning the secrets and symbols of Freemasonry, said: «All true dogmatic religions have come out of the Kabala and return to it: all that is great and scientific in religious ideals... comes from the Kabala; **all the Masonic associations owe their secrets and their symbols to the Kabala**».

In fact, the 33 degrees of the Ancient and Accepted Scottish Rite, are divided in three series of 11 degrees, where the number 11 is the mystical number of the Kabala, representing the “**deification of Man**” with the **10 divine attributes** emanated from the **Ensoph: Kingdom, Foundation, Glory, Triumph, Beauty, Justice, Mercy, Intelligence, Sapience, Crown**. This is the pantheistic lie that is:

- the denial of the eternity of the Holiest Trinity;
- the denial of the creation from nothing;
- the denial of the difference between God and the universe;
- the lowering of God to the level of His creature;
- the elevation of Man to the level of God;
- the separation of Man from God, to the perdition of his soul.

In one word: a satanic Kabala!

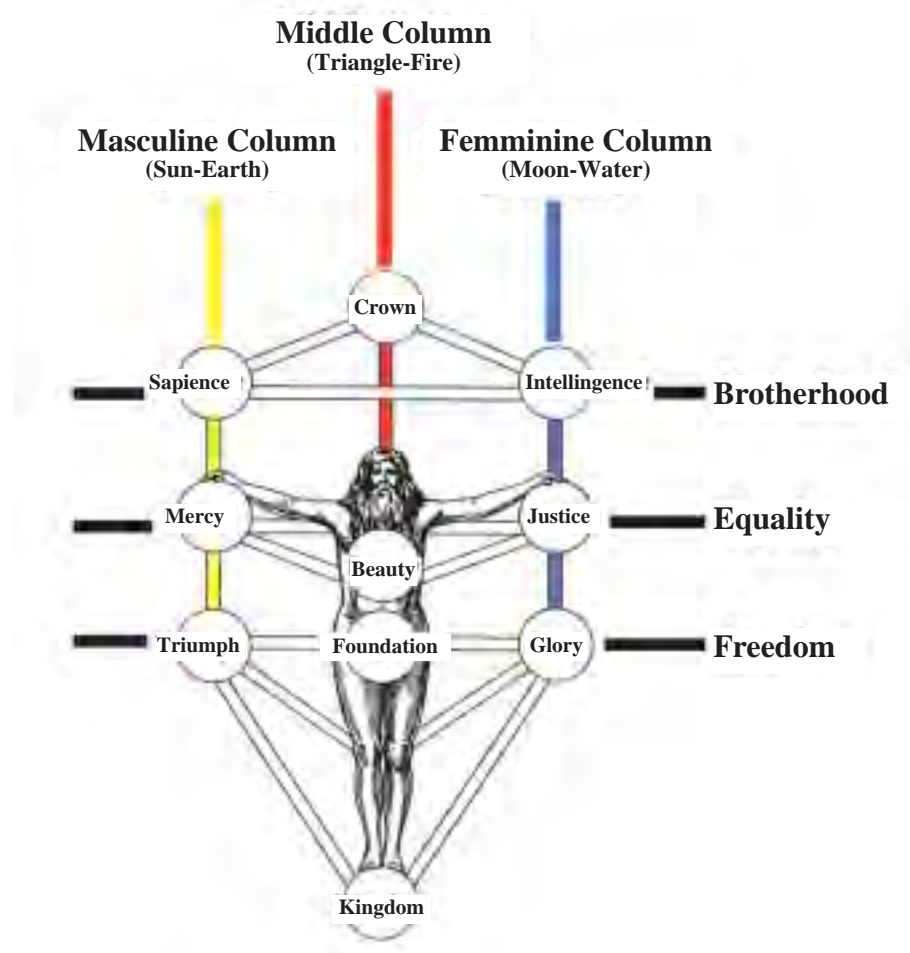

In the three Series of 11 degrees,
the Ancient and Accepted Scottish Rite
“perfects” these ten “divine attributes” of each mason
respectively promoting:
the **corruption of the Body**, by means of the “**Cult of Phallus**”,
the **corruption of the Soul**, by means of the “**Cult of Man**”,
and the **corruption of the Spirit**, by means of the “**Cult of Lucifer**”!

The Profane, animated by the “**Fire**” of rebellion against God,
with his “divine attributes”, that is his three Columns: **Earth, Water, Fire**,
enters the Temple of Masonry
as the “**rough stone**” also called the blasphemous, satanic and masonic

1st “**Holy Trinity**”.

This 1st “**Holy Trinity**” will be later smoothed into a **cubic stone** (11th degree)
and then into a **pointed cubic stone** or **Master** (15th degree),
the Man-God, the Man with the spirit freed by any divine Authority,
also called the blasphemous, satanic and masonic

2nd “**Holy Trinity**”.

Only who, among the vertex of Freemasonry, succeeds to become
Patriarch of the World and **Emperor of the World**,
he will form, together with **Lucifer in person**,
the blasphemous, satanic and masonic

3^d “**Holiest and Indivisible Trinity**”.

FIRST SERIES OF 11 DEGREES

(the corruption of the Body, by means of the “Cult of Phallus”)

The 1st Series of 11 degrees of the 33 degrees
of the Freemasonry of the Ancient and Accepted Scottish Rite
serves to fight the
“**abject Catholic Virtue**” with the “**Man-God**”.



*Heraldic emblem
of the 11th degree.*

- 1st **Kingdom - Apprentice: Recruitment:** from the Kingdom of profanes, the Candidate, animated by the **fire** of rebellion against God, the **Rough Stone**, has to be perfected into a **Cubic Stone** for the masonic **Perfect People**. This Recruitment is the **masonic Baptism** to enter the kingdom of Satan. The Candidate, at the first degree, represents the **1st HOLY TRINITY**.
-
- 2nd **Foundation - Fellow: Origin** of a **Man** with the **Cult of Phallus**. The two sexes of the Deity, added to the **Rough Stone** lead to the formation of the **Body of a Perfect Man**.
- 3rd **Glory - Master: Conception** of a son of **Lucifer**, for the glory of Lucifer who is called **Master**. “What is the fate of man? Amidst dust, corruption and worms!”
- 4th **Triumph - Secret Master: Birth** of a new conscience. Nine months from the day of Conception having passed, **the Soul enters the Body of Man:** human Conscience is to obey instincts.
-
- 5th **Beauty - Perfect Master: Cult** of deification of the human soul, as divine spark of the Primal Cause. The Matter is eternal; there exists an evil God: that one of the Christians.
- 6th **Justice - Intimate Secretary: Extension** of the human soul to the entire humanity. The human soul is a particular revelation of the universal soul revealing itself with immensity.
- 7th **Mercy - Provost and Judge: Completion:** the royal art is the government of the souls, mysterious key to move war on Faith and Religion to win the enemies.
-
- 8th **Intelligence - Intendant of the Building: War** on Holy Faith which is harmful to intelligence. Corruption of intelligence. The mason is admitted to the building of the Temple.
- 9th **Sapience - Elect of the Nine: Conquest** of Religion. Corruption of Sapience revealed for its prudence in seeking revenge of Religion. The candidate stubs the dummy of Religion.
- 10th **Crown - Elect of the Fifteen: Domination:** complete Victory over the enemies. The Candidate receives the crown when, beside the dummy of Religion, he stubs those of the Law and Property.
-
- 11th **Ensoph - Elect of the Twelve: MAN WITHOUT GOD, apogee of the Masonic Perfect People.** Adoption of a new Jewish brother for Lucifer. Human reason, revelation of divinity, is itself divine, hence independent from any authority: the **Rough Stone** has become **Cubic Stone**”, that is, **Perfect Mason**. It is sovereign: **Man is God to himself!** Hence he fulfils his duties toward himself!

SECOND SERIES OF 11 DEGREES

(the corruption of the Soul, by means of the “Cult of Man”)

The 2nd series of 11 degrees of the 33 degrees
of the Freemasonry of the Ancient and Accepted Scottish Rite
serves to fight the
“foul Catholic Morals” with the “Man-Pontiff”.



*Heraldic emblem
of the 22nd degree.*

- 12th **Kingdom - Grand Master Architect: Recruitment:** from the **Kingdom** of the **Perfect People** of the freemasons of the 1st series of 11 degrees, one must form the priestly People, elect People or Levitic People. Confession and Communion: mystic union with the Great Architect of the Universe.
-
- 13th **Foundation - Royal Arch of Solomon: Origin of a new Priest.** The **new doctrine:** pantheistic notions about the Primal Cause. The **Cult of Man** to abolish of the submission of the political and scientific power to the spiritual power of the Church. Freedom of Masonic education of the people.
- 14th **Glory - Grand Elect Perfect and Sublime Mason: Conception of a new soul of a pantheistic Priest:** the voice of conscience is hushed forever. Freedom of conscience of the people. Freedom of ignoring the ordered good and of committing the forbidden evil.
- 15th **Triumph - Knight of the East: Birth of a soul of a new Priest. Freedom of thought.** The spirit freed by any divine authority creates the **Master**, the **perfect Stone**, the **Divinized Man**, representing the **2nd HOLY TRINITY**.
-
- 16th **Beauty - Prince of Jerusalem: Cult of the new Temple:** the universal Masonic Republic founded upon a universal cult: the multi-ethnic and religiously ecumenical State.
- 17th **Justice - Knight of the East and West: Extension of Judaism in the Christian field.** The Masonic infiltration into the Church Hierarchy and its perversion.
- 18th **Mercy - Knight Rose Croix: Completion of the Masonic Antichristianism.** The Knight Rose Croix must eliminate the Sacrifice of Christ on the Cross in the Holy Mass. The Candidate becomes Jewish Pontiff!
-
- 19th **Intelligence - Grand Pontiff: War to conquer the absolute freedom of teaching** in order to lead humanity to the scientific-philosophical religion of the Gnostics.
- 20th **Sapience - Master ad Vitam: Conquest and elimination of any form of Christian “obscurantism”** as a premise to the Caesarpapism of the next degree.
- 21st **Crown - Patriarch Noachite: Domination with the Caesarpapism** exercised by the Jews over all the nations as merge of the spiritual and temporal power into the same hand.
-
- 22nd **Ensoph - Prince of Libanus: MAN PONTIFF,** apogee of the masonic **priestly People**. The King-Pontiff, worshiper and sacrificer to Lucifer. The freemason becomes Jewish Pontiff and he is called to propagate the lies, the vices and the sacrileges to which he has been initiated; in this manner, he fulfils his duties toward his neighbour!

THIRD SERIES OF 11 DEGREES

(the corruption of the Spirit, by means of the “Cult of Lucifer”)

The 3rd series of 11 degrees of the 33 degrees
of the Freemasonry of the Ancient and Accepted Scottish Rite
serves to fight the
“guilty Catholic Authority” with the “Man-King”



*Heraldic emblem
of the 33rd degree.*

- 23rd **Kingdom - Chief of the Tabernacle: Recruitment** from the Kingdom of the Priestly People of the 22nd degree, to form the **People-King** for the Masonic Government, whose political aim is to declare war on Religion and to eradicate it with shrewdness.
-
- 24th **Foundation - Prince of the Tabernacle: Origin** of a new **Lucifer** who, with the Cult of Lucifer, starts to communicate with the evil spirits. The Candidate performs the acts of faith, of submission and of worship.
- 25th **Glory - Knight of the Brazen Serpent: Conception** of a new **Lucifer**. The cult of the God Serpent: Satan replaces Christ of the Cross as man redeemer.
- 26th **Triumph - Trinitary: Birth** of a new **Lucifer** who enters the three regions of Intelligence, of Conscience, and of Reason, which correspond to the political, social and material needs of Humanity.
-
- 27th **Beauty - Commander of the Temple: Cult** of blind obedience to the hierarchical orders, premise to build the Masonic Government. Political Freedom for the new Lucifer.
- 28th **Justice - Knight of the Sun: Extension** of the army of **Lucifer**. The great secret is revealed: the spectacle of Nature and her Intelligence as sole rule of faith. Follows the most infamous libertinage and principles of black magic.
- 29th **Mercy - Knight of St. Andrew: Completion** of the Candidate's “sanctification”: act of obedience to the Supreme Master who appears under the figure of the Baphomet. The soul of the Candidate is perfectly incorporated into the kingdom of Satan.
-
- 30th **Intelligence - Knight Kadosh: War** on God. The Candidate burns scented incense to Lucifer and becomes Holy Kadosh, who wielding the dagger against heaven, chants his hatred to God with the words: “Revenge, Adonai!”.
- 31st **Sapience - Inspector Inquisitor Commander: Conquest** of the judicial Supremacy. Oath to the Masonic Authority and dissolution of any other oath made in the past to the Homeland and to the Laws.
- 32nd **Crown - Sublime Prince of the Royal Secret: Domination** of the Masonic Authority over the hatred funneled toward the Church of Christ that must be annihilated. The weapon used is the Great Pantheistic Lie from which derives the self-deification of man and the edification of a “**New Tower of Babel**”. The Motto is: “Revenge, Carnage!”.
-
- 33rd **Ensoph - Grand inspector General: MAN KING, the Man against God**, apogee of the People-King. This degree is that of the Emperor-Pope of the Masonic Caesarpapism. The double motto of this degree is: “Ordo ab chao” and “Deus meumque Jus”. Man his King to himself! And that is how he fulfils his duties toward God!

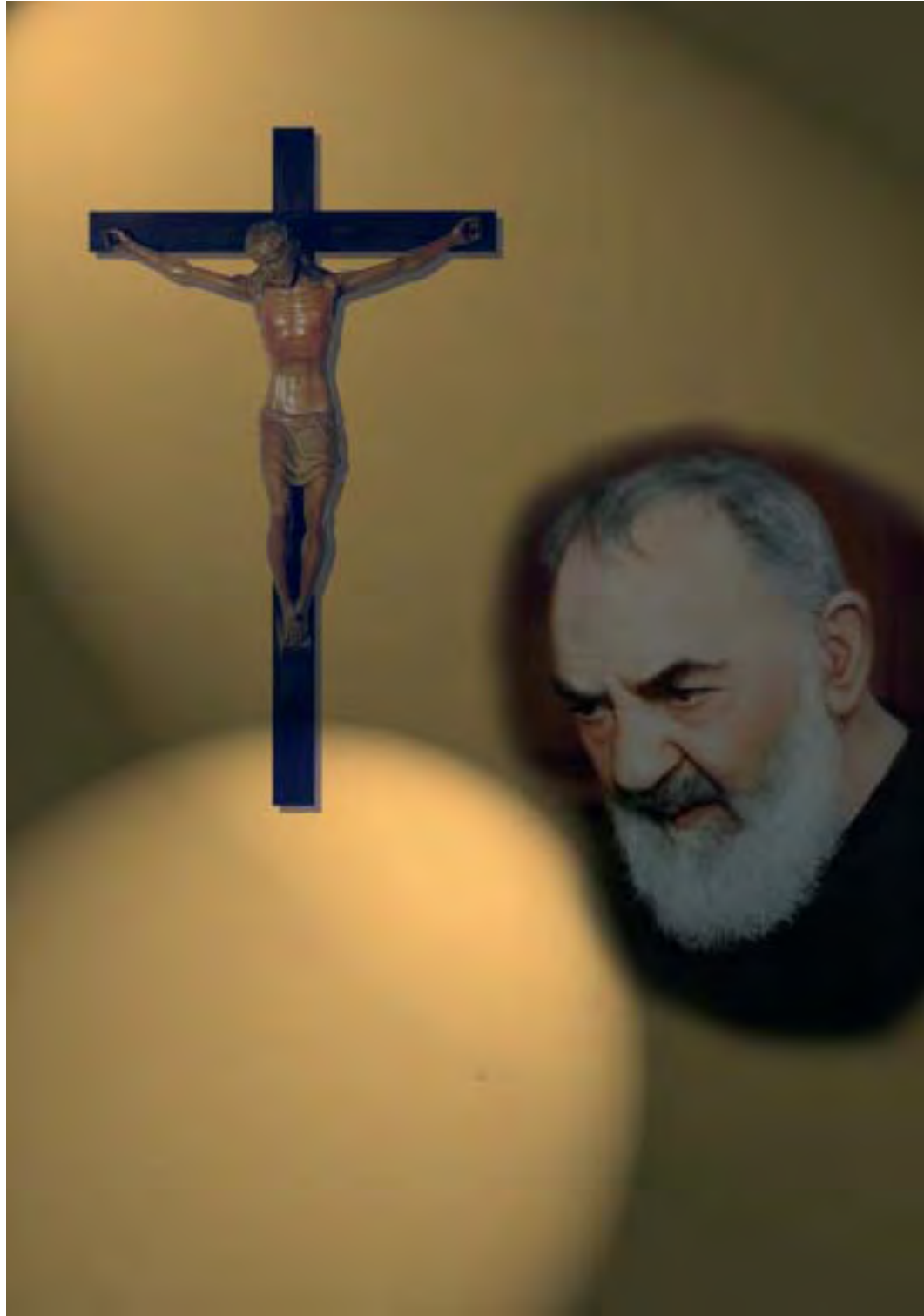

«Jesus, regrettably, has reason to complain for the ingratitude of his own ministers! How many **unfortunate brothers of ours correspond to the love of Jesus by throwing themselves with open arms **into the infamous sect of Freemasonry!**».**

(Saint Padre Pio to F. Agostino, Pietrelcina, April 7, 1913).



Pope Leo XIII.

